



## CONTENTS – 衛浴不鏽鋼系列產品

DAY & DAY 品牌介紹 .....	01
安裝前注意事項 .....	02
<b>新品 精緻霧黑</b>	
廚房龍頭 FAUCET.....	03
臉盆龍頭、沐浴龍頭、淋浴柱、滑桿 .....	04
鏡子、平台架、304 不鏽鋼 毛巾掛桿組 .....	05
304 不鏽鋼 置物架 .....	06
<b>新品 絲光系列</b>	
牙刷杯架、香皂盤架、吹風機架、馬桶刷架 .....	07、11
掛衣勾、手機座架、單 / 雙桿毛巾掛桿組、置衣架 .....	08、10
心 / 扇形置物架、置物架、置衣架 .....	09
AWA 品牌介紹 .....	13-14
AWA 檯面龍頭 AWA faucet.....	15-18
AWA 浴室感應式龍頭 AWA auto faucet.....	19
AWA 浴室龍頭 AWA faucet.....	20-21
AWA 龍頭 配件介紹 AWA accessories.....	22
龍頭 Faucet.....	23-28
水槽 Dish waser.....	29-30
環保防蟻防臭新型專利不鏽鋼後置型提籠產品特色說明 .....	31
龍頭配件 Faucet accessories.....	32
<b>衛浴配件 STA 新品系列</b>	
牙刷杯架、香皂盤架、馬桶刷架 .....	33
掛衣勾、手機座架、伸縮鏡、浴巾環、毛巾掛桿組 .....	34
衛浴毛巾置衣架 Towel & Clothes rack.....	35-37
衛浴掛架及置物架 Stainless steel rack.....	38-40
轉角架、方型置物架、面紙盒 / 架 Corner rack, Rectangle rack & Tissue rack.....	41-43
衛浴配件 Bath accessories.....	44

● 產品規格及品項價格若有調整，以實際商品為準，恕不另行通知。

● 本目錄之產品售價自 2022 年 1 月 1 日起為準。

# CONTENTS – 廚房不鏽鋼系列產品

高級衛浴 2000 系列 .....	45
毛巾掛桿組 Towel bar 1000 系列、2000 系列、3000 系列 .....	46
不鏽鋼鏡面拋光毛巾桿 Towel bar	
2600 系列、STH2700 系列、STH6100 單桿 / 雙桿 系列 .....	46
LED 鏡、易潔鏡 Mirror.....	47
高級鑽雕防霧鏡 Mirror.....	48
鏡子平台架、轉角架系列	
3500 銅固定座系列 .....	49
<b>新品</b> <b>STH3700</b> 304 不鏽鋼鏡面拋光 - 固定座系列 .....	50
旋轉直立架 Swivel stand	
雙層旋轉直立架 .....	51
三層旋轉直立架 .....	52
掛架頭 Holder.....	53
掛勾、掛桿 Hook & tube.....	54
刀柄 & 砧板架 Knife, carving board holder.....	55
調味罐架 & 砧板架 Spice, carving board holder.....	56-58
紙巾架 Paper tower rack.....	59
鍋蓋架 Lid rack.....	60
碗盤架 Bowl & Dishes holder.....	61-62
桌上型碗盤架 Tableware bowl & Dishes holder.....	63
滴水簾、水槽碗盤籃 Rollable dishes holder & Sink basket rack.....	64
餐具桶 Silver ware holder.....	65
杯架 Cup stand.....	66
隔熱墊、餐具架 Hot mat & Spoon holder.....	67
小型置物架 Small rack.....	68
高腳杯架、吊杯架、餐具 Goblet, Hanging rack, Tableware holder ....	69
感應垃圾桶 Auto sensitive dustbin .....	71
腳踏式垃圾桶 Dustbin.....	72
經典絕版品 .....	73-80



## 關於我們

營造現代舒適的生活空間，必定伴隨著良好的收納設計。DAY&DAY日日家居生活精品自1989年創立以來，以扮演優質生活的幕後推手為理念，致力於開發各式功能的掛架及收納置物架。DAY&DAY以人性為設計的價值，以機能性、高品質、及簡潔美感為設計理念，設計製造出貼近使用者的不鏽鋼生活用品。

DAY & DAY家居生活精品，配合國人各種生活需求的收納功能設計，並採用高品質304(18-8)不鏽鋼，加上頂級電鍍表面處理，針對潮濕的廚房、浴室環境，達到最高的防鏽抗腐蝕的效果，是最衛生且容易保養清理的廚衛必需品，簡潔設計能完美搭配各種的室內居家風格，創造出便利舒適的生活環境！

## 材質說明

不鏽鋼指的是以重量計，鉻含量超過11.5%的鐵合金。這個名稱源於這類的鋼材，不像普通鋼那樣容易腐蝕生鏽。而不鏽鋼也俗稱白鐵，擁有優良的耐酸、耐熱、耐蝕性，且表面不需再經處理，性質較碳鋼佳。常使用於廚房餐具、醫療衛生器材、食品加工用材。

304不鏽鋼即為此類，其標準成分是18%鉻加8%鎳，即一般所稱的18-8不鏽鋼。此類不鏽鋼的特性為無磁性，於加工過程中會出現弱磁性，無法藉由熱處理方法來改變其金相組織結構、加工性佳，又因含合金元素--鎳，所以抗蝕性較優。

### 商品特色

- MIT台灣設計製造精品
- 高品質304不鏽鋼材質
- 頂級鍍鉻表面防護處理
- 最佳收納功能產品設計
- 品項齊全滿足多元需求



### 如何保養不鏽鋼

定時保養請以溫水或稀釋之軟性清潔劑配合海綿清洗，即可輕易去除污垢，如因水中含鐵礦物質造成的表面鏽斑再以檸檬水輕拭表面，可永保亮麗如新。

亦可搭配本公司代理進口之義大利ARGITAL純天然植物配方之環保金屬清潔劑，安全無毒，保養效果更佳，請洽詢DAY&DAY 全台專櫃。

天然植物生態環保清潔劑，不含防腐劑，不傷玉手。含有天然萃取精油成分，除了不改變空氣品質之外，在使用的空間中，讓深呼吸是一件享受的事。



使用方式：直接噴灑於金屬物體表面，稍作停留，以水沖洗或以海綿洗淨。

**UI2088 NT\$ 600**

- 環保金屬清潔劑
- 含甜橙精油、薄荷精油
- 義大利原裝進口



使用方式：直接噴灑於玻璃表面，稍作停留，再以乾布或報紙擦拭。

**UI2085 NT\$ 600**

- 環保玻璃清潔劑
- 含甜橙精油
- 義大利原裝進口





## 安裝前注意事項

- 施工鑽頭為配合白色壁虎，請使用直徑 6.5~7mm 為宜。
- 不同類型的廚房掛架產品，及衛浴產品，考量不同的使用情況及承載，均有專用的螺絲(配件包)類型及長度，請勿混用。
- 產品表面應避免使用或接觸到強酸性清潔劑(如鹽酸、磁磚清潔劑)，會導致電鍍表面受損。
- **壁面產品固定墊片安裝說明**

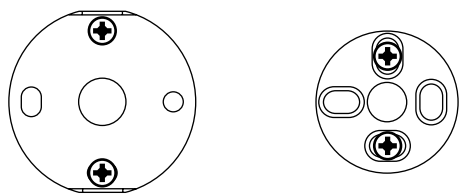

螺絲固定以上下兩點墊片承載力最佳

### • 掛架固定座 (5000C-2、5000SC-2、5000LC-2) 安裝說明

單面貼壁掛架商品，固定座宜採該商品吊掛處兩端最外側，同時於將來欲清潔時掛架仍可直接提起取下位置。

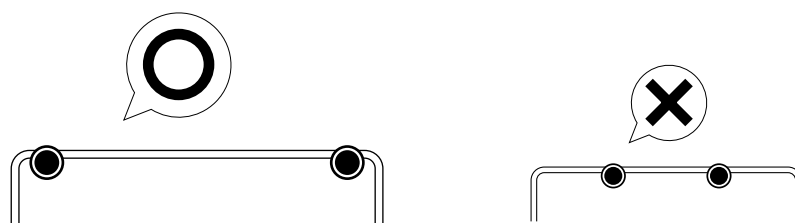

轉角式兩面貼壁掛架商品，固定座應選任單一邊吊掛處兩端最外側，同時於將來欲清潔時掛架仍可直接提起取下位置，應避免兩面各裝一顆方式。

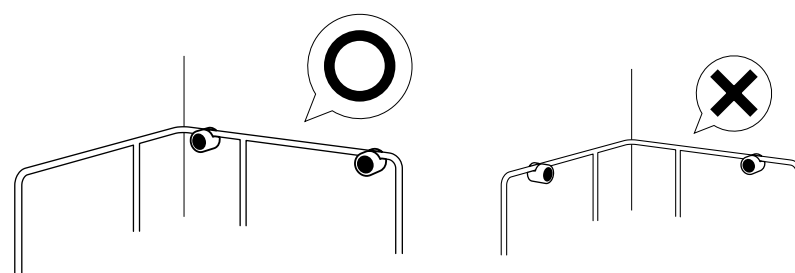





**ED-K11321BK** NT\$ 9900

- 伸縮檯面龍頭 黑色
- 附銅製加長型三角凡而



**ED-K11618-07BK** NT\$ 7600

- 檯面龍頭 黑色
- 附銅製加長型三角凡而



**ED-KA4905-B** NT\$ 16300

- PVD 花灑檯面龍頭
- 黑色 + 玫瑰金
- 附 304 不鏽鋼加長型三角凡而
- 日本陶瓷閥芯



**ED-KA4308-B** NT\$ 14300

- PVD 伸縮花灑檯面龍頭
- 黑色 + 玫瑰金
- 附 304 不鏽鋼加長型三角凡而
- 日本陶瓷閥芯



**ED-KA4903-B** NT\$ 12200

- PVD 花灑檯面龍頭
- 黑色 + 玫瑰金
- 附 304 不鏽鋼加長型三角凡而
- 日本陶瓷閥芯



**ED-F10753BK** NT\$ 9000

- 臉盆龍頭 黑色
- 附 銅製三角凡而
- 附 銅製按壓式落水頭
- 附 銅製 P 管

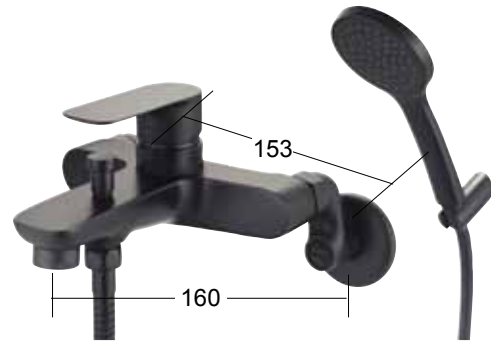

**ED-H20753BK** NT\$ 11400

- 沐浴龍頭組 黑色
- 附 ABS 蓮蓬頭
- 青銅固定座
- 150CM 軟管
- 高級止水彎頭



**ED-R20753-076BK** NT\$ 21600

- 淋浴柱 黑色
- 附 ABS 蓮蓬頭
- ABS 可調式固定座
- 150CM 軟管
- 高級止水彎頭



**ED-T22462BK** NT\$ 5600

- 滑桿 黑色
- 青銅

**M-1023B** NT\$ 6500

- 長方形易潔鏡
- 黑色 鋁框
- 可橫、直掛
- W600 X H800MM

**C2060BK** 60CM NT\$ 400**C2075BK** 75CM NT\$ 500**C2090BK** 90CM NT\$ 600

- 黑色 不鏽鋼管
- 304 STAINLESS STEEL
- Ø16MM (5分管)

**C3507BK** NT\$ 1850

- 鏡子平台架
- 附 C3500BK-2 黑色固定座 / 一對
- 黑色 BLACK
- 10MM GLASS SHELF WITH C3500BK-2 HOLDER
- 10MM 霧面強化玻璃
- W600 X D145MM

**C2600BK-2** 掛桿頭 NT\$ 1100/ 一對

- 掛桿固定座 - 黑色
- HOLDER
- 黑色 BLACK
- 303 STAINLESS STEEL 不鏽鋼
- Ø25 X D62MM

**C3500BK-2** NT\$ 1100/ 一對

- 固定座 / 一對 HOLDER
- 黑色 BLACK
- BRASS 青銅材質
- 可夾玻璃最大厚度 10MM
- W50 X D25 X H26MM

**C2660BK** 60CM NT\$ 1500**C2675BK** 75CM NT\$ 1600**C2690BK** 90CM NT\$ 1700

- 單桿毛巾掛桿組
- 黑色 BLACK
- 303 不鏽鋼掛桿固定座 + 304 不鏽鋼掛桿
- 掛桿固定座 Ø25 X D62MM( 內距 40MM)

**C2298LBK** NT\$ 5200

- 毛巾及多功能架
- 附 C5000LBK-2 掛架固定座
- 黑色 BLACK
- TOWEL SHELF & MULTI-PURPOSE RACK
- 304 STAINLESS STEEL
- W620 X D260 X H160MM

**C2CHBK** NT\$ 4800

- 雙層轉角架
- 附 C5000BK-2 掛架固定座 薄底
- 黑色 BLACK
- CORNER RACK DOUBLE S
- 304 STAINLESS STEEL
- W230 X D235X H420MM
- 內徑高度 320MM

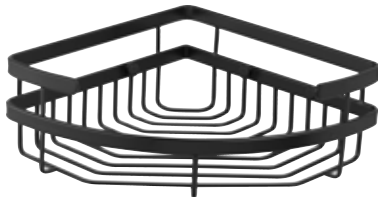
**C3266BK** NT\$ 3100

- 彎角架 (扁型線條)
- 附 C7200BK-2 螺絲固定頭 X 2
- 黑色 BLACK
- CORNER RACK
- 304 STAINLESS STEEL
- W230 X D235 X H95MM

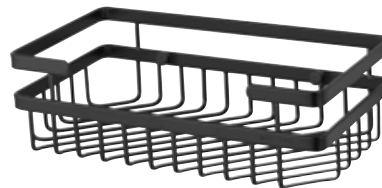
**C3267BK** NT\$ 3600

- 單層置物架 (扁型線條)
- 附 C7200BK-2 螺絲固定頭 x1
- 黑色 BLACK
- SINGLE RACK
- 304 STAINLESS STEEL
- W320 X D170 X H100MM

**C3208ABK** NT\$ 2000

- 抽取式衛生紙架
- 附 C7200BK-2 螺絲固定頭 x1
- 黑色 BLACK
- FACIAL TISSUE BOX
- 304 STAINLESS STEEL
- W256 X D120 X H90MM





**STA0031** NT\$ 1100

- 絲光 牙刷杯架
- 304 不鏽鋼 絲光
- 附透明玻璃杯 GLASS CUP
- CUP WITH HOLDER
- 304 STAINLESS STEEL
- W125 X D100 X H95MM



**STA0032** NT\$ 1100

- 絲光 香皂盤架
- 304 不鏽鋼 絲光
- 附透明香皂盤 GLASS SOAP
- SOAP DISH WITH HOLDER
- 304 STAINLESS STEEL
- W145 X D120 X H40MM



**1023** NT\$ 130

- 透明玻璃牙刷杯
- TOOTH-BRUSH CUP
- GLASS
- Ø70 X H95MM



**1024** NT\$ 180

- 透明玻璃 香皂盤
- SOAP DISH
- GLASS
- Ø110 X H40MM



**STA0033** NT\$ 1100

- 絲光 吹風機架
- 304 不鏽鋼 絲光
- 適用負離子吹風機
- HAIR DRYER HOLDER
- W150 X D114 X H22MM
- 圓內徑 86MM



**STA0035** NT\$ 1500

- 絲光 馬桶刷架
- 304 不鏽鋼 絲光
- 附馬桶刷 & 霧面玻璃杯
- TOILET BRUSH & GLASS CUP WITH HOLDER
- 304 STAINLESS STEEL
- W159 X D125 X H345MM
- 圓內徑 86MM



**STA0036** NT\$ 150

- 絲光 馬桶刷
- 304 不鏽鋼 絲光
- TOILET BRUSH
- 304 STAINLESS STEEL
- W 335MM



**1025** NT\$ 250

- 霧面玻璃 馬桶刷杯
- TOILET BRUSH CUP
- GLASS
- Ø115 X H112MM



**STA0037** NT\$ 700

- 絲光 單掛衣勾
- 304 不鏽鋼 絲光
- SIGLE ROBE HOOK
- 304 STAINLESS STEEL
- 固定座 Ø 28MM
- W29 X D50 X H65MM



**STA0038** NT\$ 800

- 絲光 雙掛衣勾
- 304 不鏽鋼 絲光
- DOUBLE ROBE HOOK
- 304 STAINLESS STEEL
- 固定座 W38 X H20
- W90 X D60 X H24MM



**STA0039** NT\$ 1500

- 絲光 手機及捲筒衛生紙架
- 304 不鏽鋼 絲光
- PAPER ROLL & PHONE HOLDER
- 304 STAINLESS STEEL
- W180 X D100 X H100MM



**STA0051-60** 60CM NT\$ 1900  
**STA0051-75** 75CM NT\$ 2100  
**STA0051-90** 90CM NT\$ 2400

- 絲光 單桿毛巾掛桿組
- 304 不鏽鋼 絲光
- TOWER BAR
- 304 STAINLESS STEEL
- 掛桿固定座 W38 X H20MM  
(內距深度 65MM)



**STA0052-60** 60CM NT\$ 2400  
**STA0052-75** 75CM NT\$ 2600  
**STA0052-90** 90CM NT\$ 2900

- 絲光 雙桿毛巾掛桿組
- 304 不鏽鋼 絲光
- TWIN TOWER BAR
- 304 STAINLESS STEEL
- 掛桿固定座 W38 X H115MM
- 內距 44MM / 內桿至外桿距離 54MM



**STA0053** NT\$ 4100

- 絲光 毛巾置衣架
- 304 不鏽鋼 絲光
- TOWER & CLOTHES SHELF
- 304 STAINLESS STEEL
- W600 X D220 X H116MM

**STA0061** NT\$ 2000

- 絲光 心形置物架
- 304 不鏽鋼 絲光
- HEART CORNER RACK
- 304 STAINLESS STEEL
- W250 X D250 X H85MM

**STA0055** NT\$ 2100

- 絲光 置衣架
- 304 不鏽鋼 絲光
- CLOTHES SHELF
- 304 STAINLESS STEEL
- W650 X D220 X H50MM

**STA0062** NT\$ 2000

- 絲光 扇形轉角架
- 304 不鏽鋼 絲光
- CORNER RACK
- 304 STAINLESS STEEL
- W230 X D230 X H80MM

**STA0056** NT\$ 2800

- 絲光 毛巾置衣架
- 304 不鏽鋼 絲光
- TOWEL & CLOTHES SHELF
- 304 STAINLESS STEEL
- W650 X D220 X H120MM

**STA0063** NT\$ 1500

- 絲光 抽取式衛生紙架
- 304 不鏽鋼 絲光
- FACIAL TISSUE HOLDER
- 304 STAINLESS STEEL
- W260 X D150 X H60MM

**STA0065** NT\$ 1800

- 絲光 置物架
- 304 不鏽鋼 絲光
- MULTI-PURPOSE RACK
- 304 STAINLESS STEEL
- W242 X D132 X H65MM



<b>ST1360</b>	60CM	NT\$ 1700
<b>ST1375</b>	75CM	NT\$ 1850
<b>ST1390</b>	90CM	NT\$ 2000

- 絲光 單桿毛巾掛桿組 5 分管
- 304 不鏽鋼絲光固定座
- 304 不鏽鋼絲光掛桿
- TOWER BAR
- 304 STAINLESS STEEL
- 掛桿固定座 Ø54 X H79 (內距 58MM)



<b>ST1300</b>	NT\$ 4100
---------------	-----------

- 絲光 毛巾置衣架
- 304 不鏽鋼絲光
- TOWER & CLOTHES SHELF
- 304 STAINLESS STEEL
- W603 X D243 X H150MM



<b>ST1560</b>	60CM	NT\$ 3000
<b>ST1575</b>	75CM	NT\$ 3200
<b>ST1590</b>	90CM	NT\$ 3400

- 絲光 雙桿毛巾掛桿組 5 分管
- 304 不鏽鋼絲光固定座
- 304 不鏽鋼絲光掛桿
- TWIN TOWER BAR
- 304 STAINLESS STEEL
- 掛桿固定座 Ø54 X H79，總高 145MM
- 低桿內距 127MM, 高桿內距 60MM



<b>ST1630</b>	30CM	NT\$ 1600
<b>ST1640</b>	40CM	NT\$ 1750
<b>ST1650</b>	50CM	NT\$ 1900
<b>ST1660</b>	60CM	NT\$ 2050

- 絲光 扶手
- 304 不鏽鋼絲光
- GRAB BAR
- 304 STAINLESS STEEL



<b>ST1016</b>	NT\$ 1200
---------------	-----------

- 絲光 單掛衣勾
- 304 不鏽鋼絲光
- SIGLE ROBE HOOK
- 304 STAINLESS STEEL
- Ø 50MM
- W50 X D67 X H62MM



<b>ST1017</b>	NT\$ 1300
---------------	-----------

- 絲光 雙掛衣勾
- 304 不鏽鋼絲光
- DOUBLE ROBE HOOK
- 304 STAINLESS STEEL
- Ø 50MM
- W77 X D67 X H50MM



**ST1001** NT\$ 1500

- 絲光 牙刷杯架
- 304 不鏽鋼絲光
- 附霧面玻璃杯 GLASS CUP
- TUMBLER CUP WITH HOLDER
- 304 STAINLESS STEEL
- W120 X D90 X H96MM

**ST1002** NT\$ 1900

- 絲光 牙刷雙杯架
- 304 不鏽鋼絲光
- 附霧面玻璃雙杯 GLASS CUP X 2
- TUMBLER CUP WITH HOLDER
- 304 STAINLESS STEEL
- W193 X D90 X H96MM

**ST1003** NT\$ 1500

- 絲光 香皂盤架
- 304 不鏽鋼絲光
- 附霧面玻璃皂盤 GLASS SOAP
- SOAP DISH WITH HOLDER
- 304 STAINLESS STEEL
- W140 X D110 X H54MM

**ST1005** NT\$ 1500

- 絲光 捲筒衛生紙架
- 304 不鏽鋼絲光
- PAPER HOLDER WITH LID
- 304 STAINLESS STEEL
- W133 X D70 X H135MM

**ST1006** NT\$ 1300

- 絲光 浴巾環
- 304 不鏽鋼絲光
- BIGGER TOWER RING
- 304 STAINLESS STEEL
- W170 X D66 X H190MM
- 圓內徑 152MM

**ST1019** NT\$ 1550

- 絲光 吹風機架
- 304 不鏽鋼絲光
- HAIR DRYER HOLDER
- 304 STAINLESS STEEL
- W100 X D118 X H110MM

**ST1012** NT\$ 1900

- 絲光 馬桶刷架
- 304 不鏽鋼絲光
- 附霧面馬桶刷杯
- TOILET BRUSH & GLASS
- CUP WITH HOLDER
- 304 STAINLESS STEEL
- W155 X D120 X H355MM
- 圓內徑 85MM





## 關於歐瓦

AWA歐瓦廚衛精品水龍頭，以「創造智慧而精工」為品牌信仰，產品堅守設計、兼顧對人和環境的尊重、可回收再利用的材質與經久實用的品質，過去已多年成功營銷歐美市場。

歐瓦創辦人駱奎思 (Christian Laudet) 擁有長時間的水龍頭生產經驗，他個人曾分別於2010與2011年獲得德國紅點設計獎 (Red Dot Award)，不僅於此，駱奎思更在成立歐瓦之後，再度獲得2013、2015紅點設計獎的肯定。與彰化鹿港水龍頭生產基地互動將近30年至今，積累豐富的台灣經驗。駱奎思觀察台灣民衆逐年地擴展設計接受度，決定帶領團隊於2015年正式在台灣啟動。結合省水節能的環保需求、視覺加上手感的震撼設計，企圖將歐洲追求迷人生活的精神引入台灣廚衛空間。

「現代法式設計，台灣製造」——是歐瓦行腳台灣的核心，由法國設計師領軍多元文化的團隊，熱愛台灣、熱愛設計，堅信優雅、智慧、實用的產品可以在台灣令國際信賴的生產技術中實現，並以技術、設計、價格競爭力三面向的謹慎考量，制定台灣市場策略。



## 環保設計：

### ● 環保省水起泡頭

歐瓦使用德國高級紐珀(Neoperl)起泡頭濾網，讓水流混合空氣，水流綿密不外濺。產生極佳的觸感，省水40%。

### ● 輕鬆清洗起泡頭—出水口的起泡頭容易拆除清洗

自來水經自來水廠、水管、水塔等管道進入家中的水龍頭，會夾雜細沙及小石頭阻塞在出水的濾網。歐瓦的起泡器僅使用銅板或一字起旋轉的方式即可打開清洗。(一般傳統須使用鉗子等工具才可以打開清洗)

### ● 二段式陶瓷閥芯—西班牙製造

可調控的二段式陶瓷閥芯，節省其餘50%的出水量。二段式的操作方法，水龍頭打開，第一段的出水量較細，只有50%的出水量，再往上推時為第二段出水量較大。二段式在切換時，相當明顯，可讓使用者明確分辨處於第一段或是第二段。

### ● ECO節能手把—保護熱水器，減少開關次數

一般混合水龍頭常在使用時自動啟動熱水器，造成能源的浪費。歐瓦的節能手把當在使用時將把手開關置於中間再打開只有冷水流出，不會啟動熱水器，有效的節省瓦斯能源。

### ● 可回收銅鑄造

全銅製造，響應環保，可回收再利用。

單一把手設計



二段式陶瓷閥芯



ECO節能手把



可回收銅鑄造



輕鬆清洗起泡頭







## HANDY 檯面無鉛龍頭

**EA-022-GB** 黑色 X 玫瑰金

NT\$ 9200

- 省水起泡頭濾網
- 輕鬆清洗起泡頭濾網
- 二段式陶瓷閥芯
- 可旋轉 U 型噴嘴
- ECO 節能手把

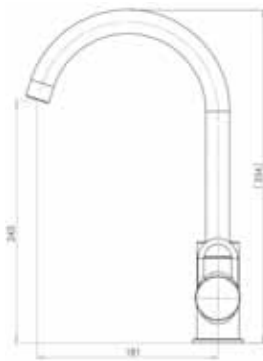

## OPHIR 檯面無鉛龍頭

**EA-135-N** 絲光鍍銀

NT\$ 13800

- 省水起泡頭濾網
- 輕鬆清洗起泡頭濾網
- 二段式陶瓷閥芯

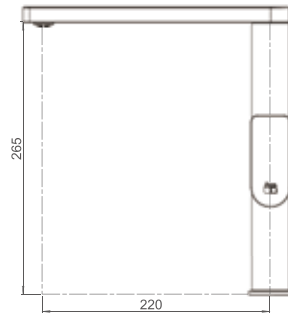

## SHERLOCK 檯面無鉛龍頭

**EA-071-GB** 黑色 X 玫瑰金

NT\$ 17000

- 省水起泡頭濾網
- 輕鬆清洗起泡頭濾網
- 二段式陶瓷閥芯
- ECO 節能手把

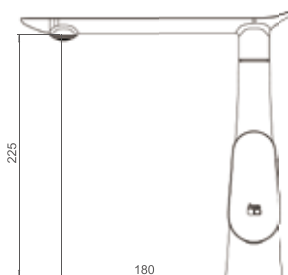

## SYDENY 檯面無鉛龍頭

**EA-105-CB** 鍍鉻 X 黑色烤漆

NT\$ 14800

- 省水起泡頭濾網
- 輕鬆清洗起泡頭濾網
- 二段式陶瓷閥芯
- 旋轉管身
- 適合小型廚房
- 德國紅點設計大獎 (Red Dot)

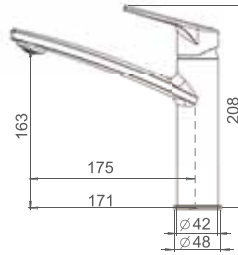

## ROBIN 檯面無鉛龍頭

**EA-194-N** 絲光鍍銀

NT\$ 14700

- 省水起泡頭濾網
- 輕鬆清洗起泡頭濾網
- 二段式陶瓷閥芯
- ECO 節能手把
- 高品質軟管握把
- 握把經隔熱處理避免燙傷
- 可活動及收納式軟管

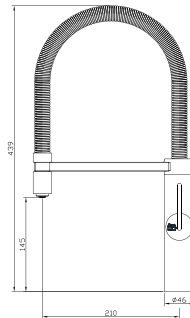

## JUN 檯面無鉛龍頭

**EA-193-GB** 黑色烤漆 x 玫瑰金

NT\$ 17900

- 省水起泡頭濾網
- 輕鬆清洗起泡頭濾網
- 二段式陶瓷閥芯
- 高品質軟管握把
- 握把經隔熱處理避免燙傷
- 可活動及收納式軟管

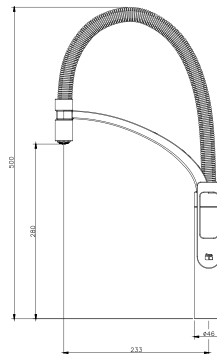

## JUN 檯面無鉛龍頭

**EA-168-N** 絲光鍍銀

NT\$ 16500

- 省水起泡頭濾網
- 二段式陶瓷閥芯
- ECO 節能手把
- 高品質軟管握把
- 握把經隔熱處理避免燙傷
- 可活動及收納式軟管

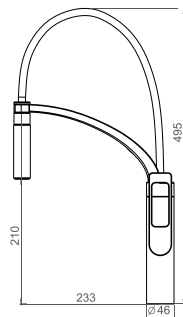

## JUN 檯面無鉛龍頭

**EA-314-GB** 黑色烤漆 X 玫瑰金

NT\$ 17500

- 省水起泡頭濾網
- 二段式陶瓷閥芯
- ECO 節能手把
- 高品質軟管握把
- 握把經隔熱處理避免燙傷
- 可活動及收納式軟管

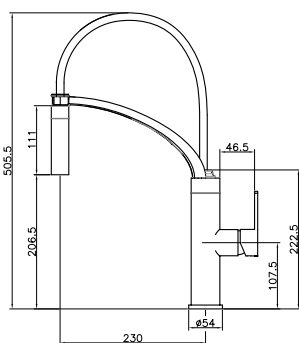

NEW

## OPHIR 花灑 檯面無鉛伸縮龍頭

**EA-353-B** 黑色烤漆

NT\$ 16800

- 省水起泡頭濾網
- 二段式陶瓷閥芯
- 雙重噴頭花灑功能

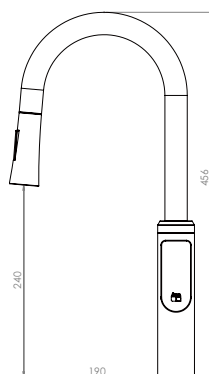

NEW



**FLEAKER 檯面無鉛伸縮龍頭**

**EA-211-GB** 黑色烤漆 X 玫瑰金 NT\$ 17200  
**EA-211-N** 絲光鍍銀 NT\$ 16600

- 省水起泡頭濾網
- 二段式陶瓷閥芯
- ECO 節能手把
- 高品質下抽拉伸縮軟管握把
- 握把經隔熱處理避免燙傷

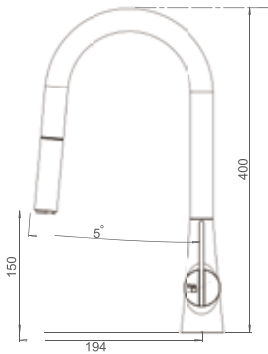

**SHERLOCK 花灑 檯面無鉛伸縮龍頭**

**EA-072-N** 絲光鍍銀 NT\$ 16500

- 省水起泡頭濾網
- 二段式陶瓷閥芯
- ECO 節能手把
- 雙重噴頭功能花灑

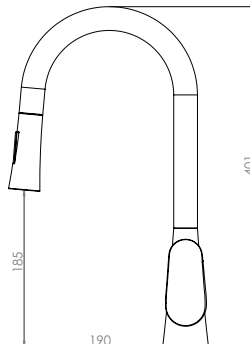



## OPHIR 浴室無鉛感應式龍頭

**EA-325-C** 絲光鍍銀

NT\$ 18500

- 非接觸式，紅外線 IR 感應出水
- 更易省水，用水完畢即自動關水
- 省水起泡頭濾網
- 輕鬆清洗起泡頭濾網
- 單冷水（不可調節水溫）
- 附電池（CR123A 2 顆）

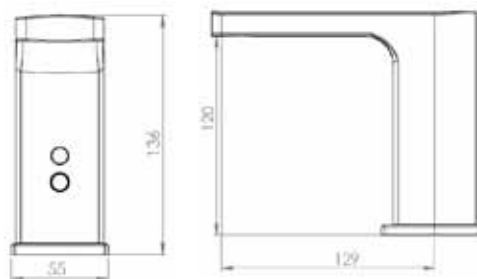

NEW

## COR IR 浴室無鉛感應式龍頭

**EA-327-B** 黑色烤漆 X 白色

NT\$ 19200

- 材質可麗耐 (Corian®): 易清潔，耐髒污。
- 非接觸式，紅外線 IR 感應出水
- 更易省水，用水完畢即自動關水
- 省水起泡頭濾網
- 輕鬆清洗起泡頭濾網
- 單冷水（不可調節水溫）
- 附電池（CR123A 2 顆）

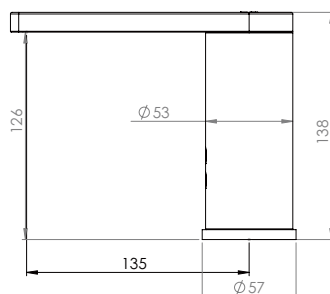

NEW



**BIBER 浴室無鉛龍頭**  
**EA-215-GW**

NT\$ 15300

- 省水起泡頭濾網
- 單一把手設計
- 把手 白色陶瓷X玫瑰金
- 管身 白色烤漆X玫瑰金

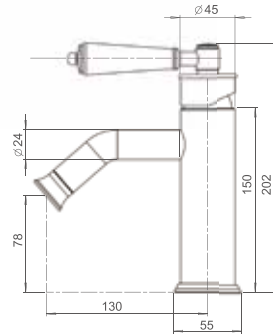

**OPHIR 浴室無鉛龍頭**

**EA-021-C** 鍍鉻 NT\$ 15300

**EA-021-CW** 鍍鉻X白色烤漆 NT\$ 16600

- 省水起泡頭濾網
- 輕鬆清洗起泡頭濾網
- ECO 節能手把
- 德國紅點設計大獎 (Red Dot)

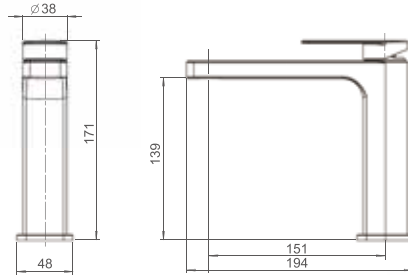

**ANGO 浴室無鉛龍頭**

**EA-160-C** 鍍鉻 NT\$ 12500

**EA-160-CW** 鍍鉻 X 白色烤漆 NT\$ 13300

- 省水起泡頭濾網
- 輕鬆清洗起泡頭濾網
- 二段式陶瓷閥芯
- ECO 節能手把

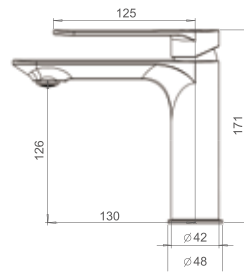

**ANGO 沐浴龍頭**

**EA-320-C** 鍍鉻 NT\$ 15200

- 省水起泡頭濾網
- 輕鬆清洗起泡頭
- 一手輕鬆調控
- 特殊閥心，輕鬆調溫
- 把手往上撥，上方蓮蓬頭出水  
把手往下撥，下方出水口出水
- 附 ABS 蓮蓬頭
- 附 ABS 固定座
- 附 304 不鏽鋼 150CM 軟管
- 附高級止水彎頭

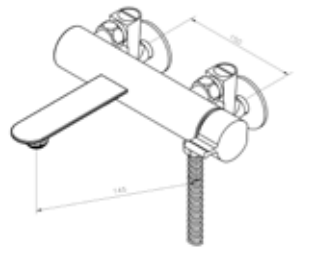



**COR 浴室無鉛龍頭**

**EA-225-N** 絲光鍍銀 NT\$ 15800

**EA-227-N** 增高-絲光鍍銀 NT\$ 17400

- 出水口方式詳見頁 16 右下
- 材質可麗耐 (Corian®) : 易清潔, 較不易卡髒污
- 普通高度 / 增高 二種樣式

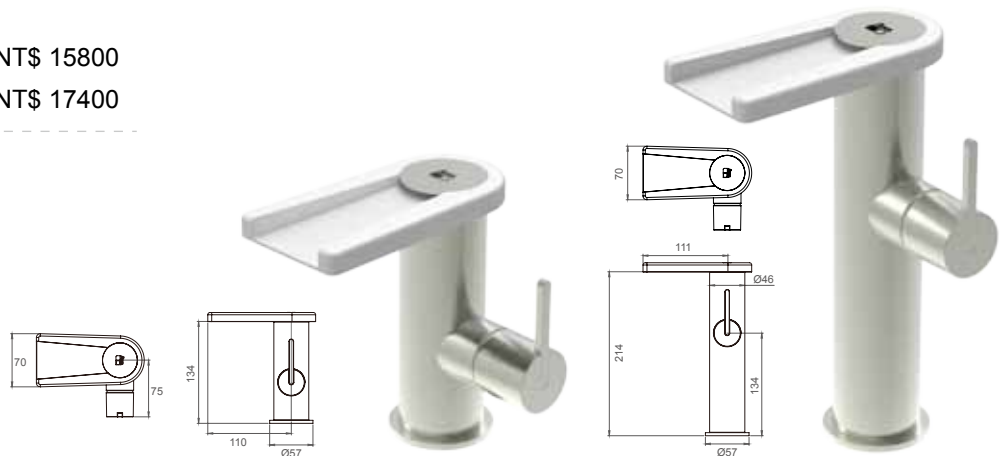

**INKY 浴室無鉛龍頭**

**EA-002-B** 黑色烤漆 NT\$ 14700

**EA-002-C** 鍍銀 NT\$ 13900

**EA-099-C** 增高-鍍銀 NT\$ 14700

- 彷彿從竹子中流出水來
- ECO 節能手把
- 普通高度 / 增高 二種樣式

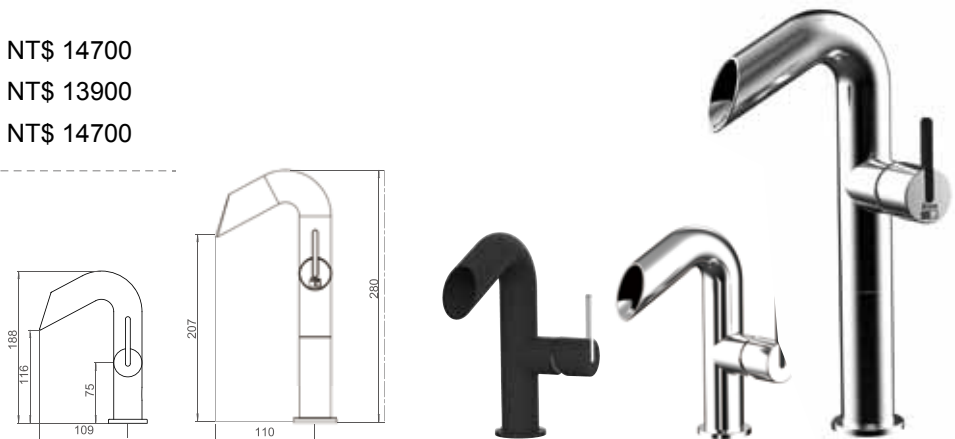

**ZENAWA 浴室無鉛龍頭**

**EA-025-N** 鍍銀 NT\$ 14700

- 彷彿從竹子中流出水來

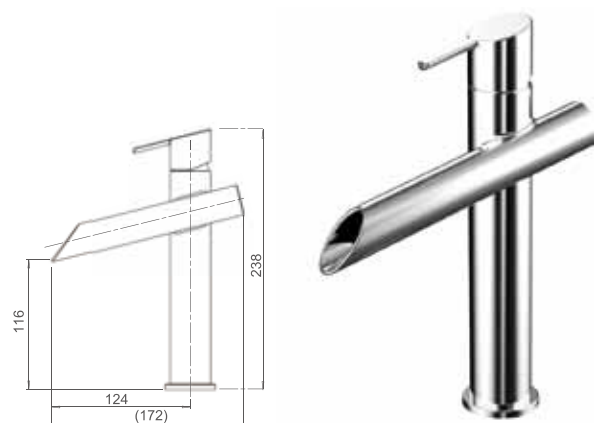



Declaration of brass composition  
relative to Lead Free

Awa Faucet Ltd products are made of  
“Lead Free” (<0.25% of Pb) compliant materials  
when in contact with water based on CNS 8088

歐瓦所製造的無鉛龍頭符合水龍頭國家標準CNS8088，其原料鉛含量低於0.25%。



— 歐瓦龍頭採用以下高級配件 —

無鉛三角凡爾



銅製P管



銅製落水頭





**ED-KS83509** NT\$ 11000

- 304 不鏽鋼無鉛龍頭
- 三用檯面龍頭
- 附 304 不鏽鋼加長型三角凡而

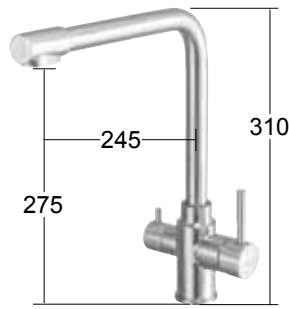

**ED-KS83503** NT\$ 10800

- 304 不鏽鋼無鉛龍頭
- 三用檯面龍頭
- 附 304 不鏽鋼加長型三角凡而

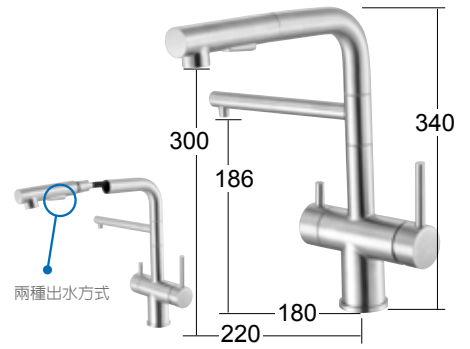

**ED-KS4022LT** NT\$ 16600

- 304 不鏽鋼無鉛龍頭
- 三用伸縮花灑檯面龍頭
- 附 304 不鏽鋼加長型三角凡而
- 日本陶瓷閥芯



**ED-KS83508** NT\$ 9900

- 304 不鏽鋼無鉛龍頭
- 伸縮花灑檯面龍頭
- 附 304 不鏽鋼加長型三角凡而



**ED-KS83505** NT\$ 9900

- 304 不鏽鋼無鉛龍頭
- 伸縮花灑檯面龍頭
- 附 304 不鏽鋼加長型三角凡而



**ED-KS4020** NT\$ 10900

- 304 不鏽鋼無鉛龍頭
- 流線型伸縮花灑檯面龍頭
- 附 304 不鏽鋼加長型三角凡而
- 日本陶瓷閥芯



**ED-KS83501** NT\$ 5300

- 304 不鏽鋼無鉛龍頭
- 檯面龍頭
- 附 304 不鏽鋼加長型三角凡而



**ED-KS83502** NT\$ 6400

- 304 不鏽鋼無鉛龍頭
- 檯面龍頭
- 附 304 不鏽鋼加長型三角凡而

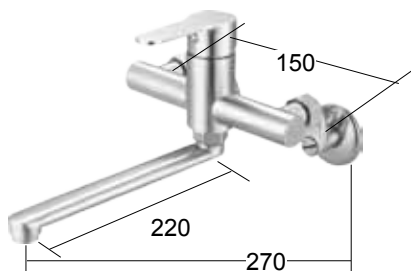

**ED-KS83506** NT\$ 6400

- 304 不鏽鋼無鉛龍頭
- 壁式龍頭
- 附 304 不鏽鋼止水彎頭



**ED-KS83507** NT\$ 5600

- 304 不鏽鋼無鉛龍頭
- 檯面龍頭
- 附 304 不鏽鋼加長型三角凡而



**ED-K11326** NT\$ 8650

- 伸縮花灑檯面龍頭
- 附銅製加長型三角凡而



**ED-K11327** NT\$ 8650

- 伸縮花灑檯面龍頭
- 附銅製加長型三角凡而



**ED-11321** NT\$ 8400

- 伸縮檯面龍頭
- 附銅製加長型三角凡而



**ED-K11314** NT\$ 9900

- 三用檯面龍頭
- 附銅製加長型三角凡而



**ED-K11311** NT\$ 7400

- 伸縮檯面龍頭
- 附銅製加長型三角凡而



**ED-10368** NT\$ 5400

- 檯面龍頭
- 附銅製加長型三角凡而



**ED-K10160** NT\$ 6000

- 檯面龍頭
- 附銅製加長型三角凡而





**ED-FS20171** NT\$ 7500

- 304 不鏽鋼無鉛龍頭
- 臉盆龍頭
- 附 304 不鏽鋼加長型三角凡而
- 附銅製按壓式落水頭
- 附銅製 P 管
- 日本陶瓷閥芯

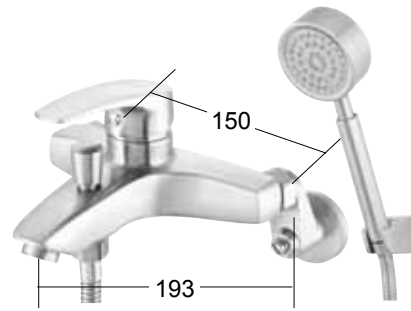

**ED-HS4018-01** NT\$ 12200

- 304 不鏽鋼無鉛龍頭
- 沐浴龍頭組
- 304 不鏽鋼蓮蓬頭
- 附 304 不鏽鋼固定座
- 附 304 不鏽鋼 150CM 軟管
- 附 304 大流量止水彎頭
- 日本陶瓷閥芯



**ED-FS20173A** NT\$ 7500

- 304 不鏽鋼無鉛龍頭
- 臉盆龍頭
- 附 304 不鏽鋼加長型三角凡而
- 附銅製按壓式落水頭
- 附銅製 P 管
- 日本陶瓷閥芯



**ED-HS4017A-01** NT\$ 13800

- 304 不鏽鋼無鉛龍頭
- 沐浴龍頭組
- 304 不鏽鋼蓮蓬頭
- 附 304 不鏽鋼固定座
- 附 304 不鏽鋼 150CM 軟管
- 附 304 大流量止水彎頭
- 日本陶瓷閥芯



**ED-FS18766** NT\$ 8600

- 304 不鏽鋼無鉛龍頭
- 臉盆龍頭
- 附 304 不鏽鋼蓮蓬頭
- 附 304 不鏽鋼固定座
- 附 304 不鏽鋼 150CM 軟管
- 附 304 不鏽鋼三角凡而
- 附銅製按壓式落水頭
- 附銅製 P 管

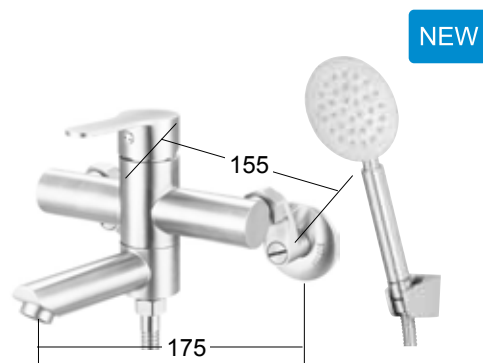

**ED-HS28765** NT\$ 7300

- 304 不鏽鋼無鉛龍頭
- 沐浴龍頭組
- 附 304 不鏽鋼蓮蓬頭
- 附 304 不鏽鋼固定座
- 附 304 不鏽鋼 150CM 軟管
- 附 304 不鏽鋼止水彎頭

**產品特色**

- 水龍頭出水管向左撥，上方蓮蓬頭出水，不佔淋浴空間。
- 出水管置於中間，下方出水管出水。



**ED-FS18761** NT\$ 6800

- 304 不鏽鋼無鉛龍頭
- 臉盆龍頭
- 附 304 不鏽鋼三角凡而
- 附銅製按壓式落水頭
- 附銅製 P 管

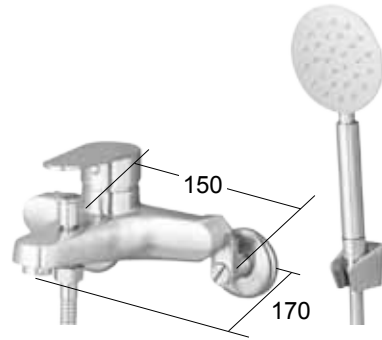

**ED-HS28761** NT\$ 8400

- 304 不鏽鋼無鉛龍頭
- 沐浴龍頭組
- 附 304 不鏽鋼蓮蓬頭
- 附 304 不鏽鋼固定座
- 附 304 不鏽鋼 150CM 軟管
- 附 304 不鏽鋼止水彎頭



**ED-FS18763** NT\$ 6200

- 304 不鏽鋼無鉛龍頭
- 臉盆龍頭
- 附 304 不鏽鋼三角凡而
- 附銅製按壓式落水頭
- 附銅製 P 管

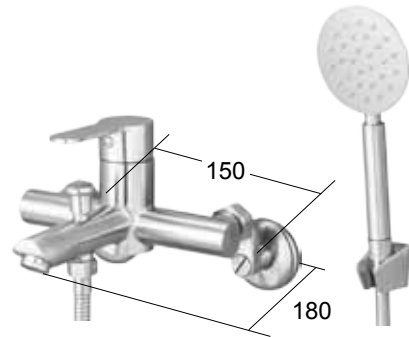

**ED-HS28763** NT\$ 7300

- 304 不鏽鋼無鉛龍頭
- 沐浴龍頭組
- 附 304 不鏽鋼蓮蓬頭
- 附 304 不鏽鋼固定座
- 附 304 不鏽鋼 150CM 軟管
- 附 304 不鏽鋼止水彎頭



**ED-VS8651** NT\$ 2200

- 304 不鏽鋼
- 沖洗器
- 附 304 不鏽鋼固定座
- 附 304 不鏽鋼 150CM 軟管
- 附 304 不鏽鋼控制閥進水三通



**ED-VS8651A** NT\$ 1900

- 304 不鏽鋼
- 沖洗器
- 附 304 不鏽鋼固定座
- 附 304 不鏽鋼 150CM 軟管
- 附 304 不鏽鋼三角凡而



**ED-F10753** NT\$ 6900

- 臉盆龍頭
- 附銅製三角凡而
- 附銅製按壓式落水頭
- 附銅製 P 管

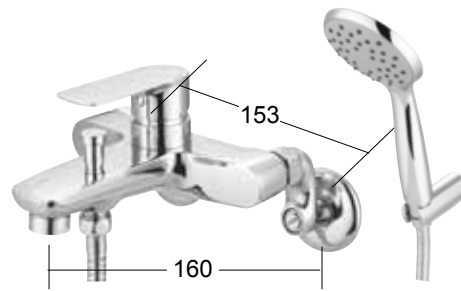

**ED-H20753A** NT\$ 8250

- 沐浴龍頭組
- 附 ABS 蓮蓬頭
- 附青銅固定座
- 附 304 不鏽鋼 150CM 軟管
- 附高級止水彎頭



**ED-F11613R** NT\$ 5500

- 臉盆龍頭
- 附銅製三角凡而
- 附銅製按壓式落水頭
- 附銅製 P 管

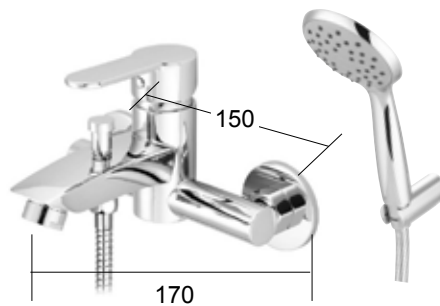

**ED-H22613RB** NT\$ 7500

- 沐浴龍頭組
- 附 ABS 蓮蓬頭
- 附青銅固定座
- 附 304 不鏽鋼 150CM 軟管
- 附高級止水彎頭



**ED-F18116** NT\$ 6950

- 臉盆龍頭
- 附銅製三角凡而
- 附銅製按壓式落水頭
- 附銅製 P 管



**ED-H28126** NT\$ 8950

- 沐浴龍頭組
- 附 ABS 蓮蓬頭
- 附青銅固定座
- 附 304 不鏽鋼 150CM 軟管
- 附高級止水彎頭

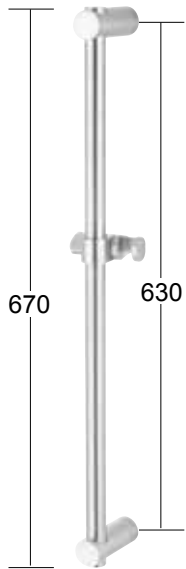

### ED-TS01

NT\$ 4100

- 高級活動滑桿
- 304 不鏽鋼

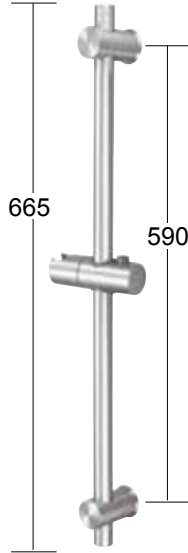

### ED-T6507

NT\$ 3500

- 滑桿
- 304 不鏽鋼

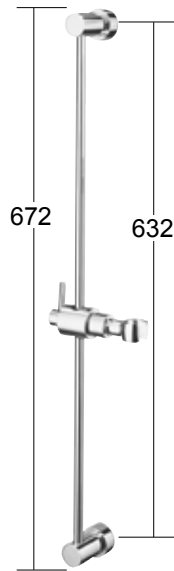

NEW

### ED-T22462

NT\$ 3950

- 滑桿
- 青銅



### ED-RS70016-01 NT\$ 23000

- 304 不鏽鋼無鉛龍頭
- 高級淋浴柱
- 直桿高度：78CM~145CM
- 附 304 不鏽鋼蓮蓬頭
- 304 不鏽鋼可調式固定座
- 附 304 不鏽鋼 150CM 軟管
- 附 304 大流量止水彎頭
- 日本陶瓷閥芯



NEW

### ED-RS28501 NT\$ 16800

- 304 不鏽鋼無鉛龍頭
- 淋浴柱
- 直桿高度：120CM ~ 145CM
- 附 304 不鏽鋼蓮蓬頭
- 附 304 不鏽鋼固定座
- 附 304 不鏽鋼 150CM 軟管
- 附 304 不鏽鋼止水彎頭



NEW

### ED-R28126-076 NT\$ 17800

- 淋浴柱
- 直桿高度：115CM ~ 145CM
- 附 ABS 蓮蓬頭
- ABS 可調式固定座
- 304 不鏽鋼 150CM 軟管
- 高級止水彎頭



NEW

### DD9487

NT\$ 25000

- 手工小 R 角方槽
- 髮絲紋
- STAINLESS SINK
- 人造石下嵌、天然石 / 美耐板上裝、不鏽鋼檯面平接

材 質	304 STAINLESS STEEL
外 徑	OUTSIDE DIA. 870X460X220MM
內 徑	INSIDE DIA. 830X420X220MM
厚 度	THICKNESS 1.1MM
適用桶身	90CM 以上
底部貼防潮消音墊、無溢水孔 ST 後置型大提籠、ST 半邊籃、ST 瀝水盆	



NEW

### DD9477

NT\$ 20900

- 手工小 R 角方槽
- 髮絲紋
- STAINLESS SINK
- 人造石下嵌、天然石 / 美耐板上裝、不鏽鋼檯面平接

材 質	304 STAINLESS STEEL
外 徑	OUTSIDE DIA. 770X460X220MM
內 徑	INSIDE DIA. 730X420X220MM
厚 度	THICKNESS 1.1MM
適用桶身	80CM 以上
底部貼防潮消音墊、無溢水孔 ST 後置型大提籠、ST 瀝水盆	



NEW

### DD9467

NT\$ 18500

- 手工小 R 角方槽
- 髮絲紋
- STAINLESS SINK
- 人造石下嵌、天然石 / 美耐板上裝、不鏽鋼檯面平接

材 質	304 STAINLESS STEEL
外 徑	OUTSIDE DIA. 670X460X220MM
內 徑	INSIDE DIA. 630X420X220MM
厚 度	THICKNESS 1.1MM
適用桶身	70CM 以上
底部貼防潮消音墊、無溢水孔 ST 後置型大提籠、ST 瀝水盆	



NEW

### DD9456

NT\$ 16500

- 手工小 R 角方槽
- 髮絲紋
- STAINLESS SINK
- 人造石下嵌、天然石 / 美耐板上裝、不鏽鋼檯面平接

材 質	304 STAINLESS STEEL
外 徑	OUTSIDE DIA. 560X460X220MM
內 徑	INSIDE DIA. 520X420X220MM
厚 度	THICKNESS 1.1MM
適用桶身	60CM 以上
底部貼防潮消音墊、無溢水孔 ST 後置型中提籠、方槽用 ST 半邊籃	



NEW

### DD0166

NT\$ 19500

- 歐式方形大單槽
- 柔絲面
- STAINLESS SINK
- 人造石下嵌、天然石 / 美耐板上裝、不鏽鋼檯面平接

材 質	304 STAINLESS STEEL
外 徑	OUTSIDE DIA. 800x520x230MM
內 徑	INSIDE DIA. 735x460x225MM
厚 度	THICKNESS 1.0MM
適用桶身	80CM 以上
底部貼防潮消音墊、無溢水孔 ST 後置型大提籠、ST 半邊籃、ST 掛籃	



### DD0167

NT\$ 13800

- 歐式全四方單槽
- 柔絲面
- STAINLESS SINK
- 人造石下嵌、天然石 / 美耐板上裝、不鏽鋼檯面平接

材 質	STAINLESS STEEL	SUS 304 柔絲面
外 徑	OUTSIDE DIA.	710X450X225MM
內 徑	INSIDE DIA.	680X420X220MM
厚 度	THICKNESS	1.0MM
適用桶身		75CM 以上
底部貼防潮消音墊、無溢水孔 ST 後置型大提籠、ST 掛籃		



### DD9449-01

NT\$ 13300

- 手工小 R 角方槽
- 髮絲紋
- STAINLES SINK
- 人造石下嵌、天然石 / 美耐板上裝、不鏽鋼檯面平接

材 質	STAINLESS STEEL	304 髮絲紋
外 徑	OUTSIDE DIA.	490X460X220MM
內 徑	INSIDE DIA.	450X420X220MM
厚 度	THICKNESS	1.1MM
適用桶身		55CM 以上
ST 後置型中提籠、無溢水孔、底部貼防潮消音墊		



### DD9434

NT\$ 10600

- 手工小 R 角方槽
- 髮絲紋
- STAINLES SINK
- 人造石下嵌、天然石 / 美耐板上裝、不鏽鋼檯面平接

材 質	STAINLESS STEEL	304 髮絲紋
外 徑	OUTSIDE DIA.	340X460X220MM
內 徑	INSIDE DIA.	300X420X220MM
厚 度	THICKNESS	1.1MM
適用桶身		40CM 以上
ST 後置型小提籠、無溢水孔、底部貼防潮消音墊		



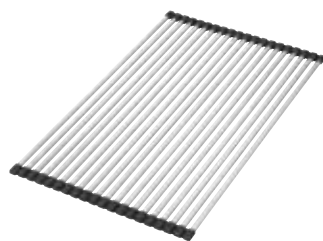

**ST3052** NT\$ 3900

- 全展 W316 X D506MM
- 收納 Ø53 X D506MM
- 適用四方型水槽



**ST3052L** NT\$ 4350

- 全展 W316 X D546MM
- 收納 Ø53 X D546MM
- 適用海灣型水槽

- 滴水捲簾
- ROLLABLE DISHES HOLDER
- 304 STAINLESS STEEL
- 食用級耐熱矽膠
- 20 支 304 不鏽鋼扁條



**DD0168FN**

NT\$ 17600

- 大愛琴海
- 柔絲面
- STAINLESS SINK
- 人造石下嵌、天然石 / 美耐板上裝、不鏽鋼檯面平接

材 質	STAINLESS STEEL	SUS 304 柔絲面
外 徑	OUTSIDE DIA.	820X520X230MM
內 徑	INSIDE DIA.	760X460X215MM
厚 度	THICKNESS	1.0MM
適用桶身		85CM 以上
底部貼防潮消音墊、無溢水孔 ST 後置型大提籠、ST 掛籃、ST 半邊籃		



**DD0101B**

NT\$ 14200

- 愛琴海單槽
- 柔絲面
- STAINLESS SINK
- 人造石下嵌、天然石 / 美耐板上裝、不鏽鋼檯面平接

材 質	STAINLESS STEEL	SUS 304 柔絲面
外 徑	OUTSIDE DIA.	700X510X230MM
內 徑	INSIDE DIA.	650X460X215MM
厚 度	THICKNESS	0.7MM
適用桶身		75CM 以上
底部貼防潮消音墊、無溢水孔 ST 後置型大提籠、ST 半邊籃、ST 多功能掛籃		



NEW

**DD0502**

NT\$ 8100

- 大原槽
- 毛絲面
- STAINLESS SINK
- 人造石下嵌、不鏽鋼檯面平接

材 質	304 STAINLESS STEEL	
內 徑	INSIDE DIA.	740X420X200MM
厚 度	THICKNESS	0.7MM
適用桶身		80CM 以上
底部貼防潮消音墊、有溢水孔 ST 後置型中提籠		



NEW

**DD0505**

NT\$ 5000

- 大原槽
- 毛絲面
- STAINLESS SINK
- 人造石下嵌、不鏽鋼檯面平接

材 質	304 STAINLESS STEEL	
內 徑	INSIDE DIA.	560X410X200MM
厚 度	THICKNESS	0.6MM
適用桶身		65CM 以上
底部貼防潮消音墊、有溢水孔 ST 後置型中提籠		



**DD0301-01**

NT\$ 5600

- 大橢圓
- 毛絲面
- STAINLESS SINK
- 人造石下嵌、天然石 / 美耐板上裝、不鏽鋼檯面平接

材 質	STAINLESS STEEL	304 毛絲面
外 徑	OUTSIDE DIA.	620X480X205MM
內 徑	INSIDE DIA.	560X410X200MM
厚 度	THICKNESS	0.6MM
適用桶身		65CM 以上
ST 後置型中提籠、有溢水孔、底部貼防潮消音墊		



**DD0006F**

NT\$ 6800

- 圓形吧檯槽
- 毛絲面
- ROUND BAR SINK
- 人造石下嵌、天然石 / 美耐板上裝、不鏽鋼檯面平接

材 質	STAINLESS STEEL	304 毛絲面
外 徑	OUTSIDE DIA.	435X435X185MM
內 徑	INSIDE DIA.	380X380X180MM
厚 度	THICKNESS	0.7MM
適用桶身		50CM 以上
ST 後置型小提籠、無溢水孔、附落水頭		

## 環保防蟑防臭新型專利 不鏽鋼後置型大提籠

## 環保防蟑防臭新型專利 不鏽鋼後置型中提籠



◎ 實例圖 適用 18 公分提籠孔



◎ 洗碗機專用接法示意圖



◎ 實例圖 適用 14.5 公分提籠孔

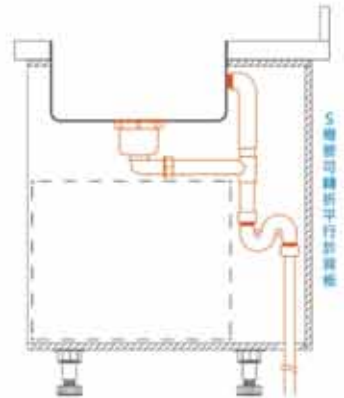

◎ 櫃體安裝示意圖



### 產品特色

#### 後置式設計：

傳統櫥櫃內空間常因排水管置於中間貫穿上下，造成空間難以利用，本公司研發的新型提籠組獨特後置式設計將出口轉向後方，櫥櫃內空間不再因排水管而有所阻礙，無論是搭配櫥下拉籃或是抽屜、隔板都更為方便。

#### S 彎管防蟑防臭：

下方的 S 彎管設計，利用水將蟑螂及排水管臭味阻絕於外，達到防蟑防臭的效果。

#### 超淺提籠高度：

將水槽下提籠高度由傳統約 30 公分減淺至 15 公分，櫥下空間自由利用。

#### 功能齊全：

沉水彎處預先留有洗碗機排水孔及汙物清潔孔，毋須另行加裝三通配件，櫥下空間更簡潔。



◎ 防蟑防臭示意圖



**ED-VS3007** NT\$ 700

- 蓮蓬頭
- 304 不鏽鋼



**ED-VS24089** NT\$ 950

- 蓮蓬頭
- 304 不鏽鋼



**ED-VS10S** NT\$ 500

- 固定座
- 304 不鏽鋼



**ED-V6025CP** NT\$ 550

- 蓮蓬頭
- ABS



**ED-V24137** NT\$ 550

- 蓮蓬頭
- ABS



**ED-V32013** NT\$ 1100

- 三段式蓮蓬頭
- ABS 絲光



**ED-VS04055A** NT\$ 580

- 加密軟管
- 304 不鏽鋼
- 150CM



**ED-V24088BK** NT\$ 650

- 蓮蓬頭
- ABS
- 黑色



**ED-VS992B** NT\$ 650

- 加長型三角凡而
- 304 不鏽鋼



**ED-VY33019** NT\$ 760

- 三角凡而
- 銅



**STA0001** NT\$ 900

- 牙刷杯架
- 304 不鏽鋼
- 附透明玻璃杯 GLASS CUP
- TUMBLER CUP WITH HOLDER
- 304 STAINLESS STEEL
- W67 X D110 X H100MM



**STA0002** NT\$ 900

- 香皂盤架
- 304 不鏽鋼
- 附透明香皂盤 GLASS SOAP
- SOAP DISH WITH HOLDER
- 304 STAINLESS STEEL
- W110 X D130 X H68MM



**1023** NT\$ 130

- 透明玻璃牙刷杯
- TOOTH-BRUSH CUP
- GLASS
- Ø70X H95MM



**1024** NT\$ 180

- 透明玻璃 香皂盤
- SOAP DISH
- GLASS
- Ø110 X H40MM



**STA0005** NT\$ 1350

- 馬桶刷架
- 304 不鏽鋼
- 附霧面玻璃杯 & 馬桶刷
- TOILET BRUSH & GLASS CUP WITH HOLDER
- 304 STAINLESS STEEL
- W112 X D132 X H345MM
- 圓內徑 86MM



**STA0006** NT\$ 150

- 馬桶刷
- 304 不鏽鋼
- TOILET BRUSH
- 304 STAINLESS STEEL
- W335MM



**1025** NT\$ 250

- 霧面玻璃 馬桶刷杯
- TOILET BRUSH CUP
- GLASS
- Ø115 X H112MM



**STA0007** NT\$ 800

- 單掛衣勾
- 304 不鏽鋼
- SIGLE ROBE HOOK
- 304 STAINLESS STEEL
- W60 X D57 X H60MM



**STA0010** NT\$ 3300

- 壁掛式雙面伸縮鏡
- 304 不鏽鋼
- REVERSIBLE WALL-EXTENSION MIRROR
- 304 STAINLESS STEEL
- 鏡面 Ø180MM
- 底座 W48 X H125MM
- 伸縮長度：  
一段 245MM / 二段 445MM  
平面·放大 (放大三倍)



**STA0008** NT\$ 900

- 雙掛衣勾
- 304 不鏽鋼
- DOUBLE ROBE HOOK
- 304 STAINLESS STEEL
- W90 X D70 X H60MM



**STA0011** NT\$ 1000

- 浴巾架
- 304 不鏽鋼
- BIGGER TOWER RING
- 304 STAINLESS STEEL
- W170 X D67 X H195MM
- 圓內徑：145MM



**STA0009** NT\$ 1800

- 手機及捲筒衛生紙架
- 304 不鏽鋼
- PAPER ROLL & PHONE HOLDER
- 304 STAINLESS STEEL
- W185 X D118 X H78MM



**STA0012-60** 60CM NT\$ 1500

**STA0012-75** 75CM NT\$ 1700

- 單桿毛巾掛桿組
- 304 不鏽鋼
- TOWER BAR
- 304 STAINLESS STEEL
- 掛桿固定座 Ø60MM (內距 62MM)





**ST2268-1** NT\$ 1600

- 雙層毛巾桿
- DOUBLE TOWEL BAR
- 304 STAINLESS STEEL
- W666 X D152 X H212MM



**ST2268-2** NT\$ 2250

- 雙層毛巾置物架
- DOUBLE TOWEL SHELF
- 304 STAINLESS STEEL
- W666 X D250 X H212MM

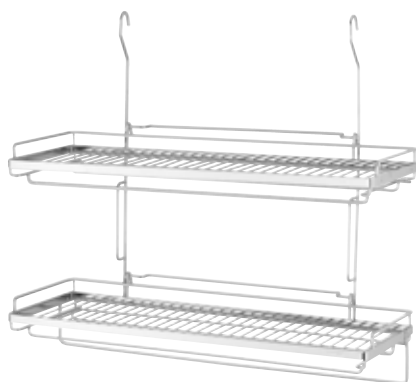

**ST3068BS** NT\$ 6800

- 雙層置物架
- DOUBLE RACK
- 304 STAINLESS STEEL
- W625 X D250 X H620MM
- 內徑高度 220MM



**ST2268-3** NT\$ 2800

- 三層毛巾置物架
- TRIPLE TOWEL SHELF
- 304 STAINLESS STEEL
- W666 X D250 X H273MM



**ST2269L-1** NT\$ 2150

- 毛巾架
- DOUBLE TOWEL BAR
- 304 STAINLESS STEEL
- W666 X D152 X H212MM

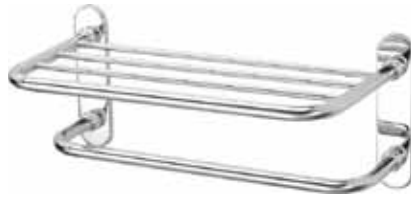

**ST2269L-2** NT\$ 2750

- 毛巾置衣架
- TOWEL & CLOTHES SHELF
- 304 STAINLESS STEEL
- W666 X D250 X H212MM



**ST2269L-3** NT\$ 3500

- 毛巾置衣架
- TOWEL & CLOTHES SHELF
- 304 STAINLESS STEEL
- W666 X D250 X H273MM



**ST2269S-1** NT\$ 1950

- 毛巾架
- DOUBLE TOWEL BAR
- 304 STAINLESS STEEL
- W510 X D152 X H212MM



**ST2269S-2** NT\$ 2600

- 毛巾置衣架
- TOWEL & CLOTHES SHELF
- 304 STAINLESS STEEL
- W510 X D250 X H212MM



**ST2269S-3** NT\$ 3300

- 毛巾置衣架
- TOWEL & CLOTHES SHELF
- 304 STAINLESS STEEL
- W510 X D250 X H273MM



**ST6678DP** 扁條 NT\$ 5250

- 雙層置物架 (掛、放兩用)
- 附 5000C-2 掛架固定座 薄底
- DOUBLE RACK
- 304 STAINLESS STEEL
- W468 X D280 X H440MM
- 內徑高度 336MM



**ST3078F** NT\$ 5900

- 雙層置物架 (掛、放兩用)
- 附 3061-50 大滴水盤 X2
- 附 5000SC-2 掛架固定座 厚底
- DOUBLE MULTI-PURPOSE RACK
- 304 STAINLESS STEEL
- W575 X D245 X H460MM
- 內徑高度 303MM



**ST2298SD-02** NT\$ 4000

- 雙層毛巾及多功能架-單桿
- 附 5000LC-2 掛架固定座
- TOWEL SHELF & DOUBLE MULTI-PURPOSE RACK
- 304 STAINLESS STEEL
- W380 X D200 X H400MM
- 內徑高度 270MM



**ST2298LDH** NT\$ 2500

- 多功能置物架-窄版
- 附 5000LC-2 掛架固定座
- MULTI-PURPOSE RACK
- 304 STAINLESS STEEL
- W620 X D200 X H65MM



**ST2298LD-1** NT\$ 3200

- 毛巾及多功能架-窄版-單桿
- 附 5000LC-2 掛架固定座
- TOWEL SHELF & MULTI-PURPOSE RACK
- 304 STAINLESS STEEL
- W620 X D200 X H127MM



**ST2298L-2A** NT\$ 4000

- 毛巾置物架-雙桿
- 附 5000SC-2 掛架固定座 厚底
- TOWEL SHELF & MULTI-PURPOSE RACK
- 304 STAINLESS STEEL
- W610 X D240 X H200MM



**ST2298SH** NT\$ 2850

(實景詳見頁 35)

- W460 X D260 X H65MM

**ST2298LH** NT\$ 3300

- W620 X D260 X H65MM

- 多功能架
- 附 5000LC-2 掛架固定座
- MULTI-PURPOSE RACK
- 304 STAINLESS STEEL

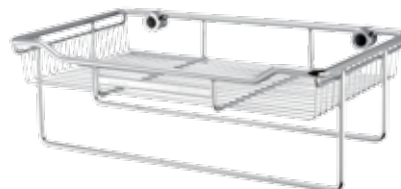

**ST2298S** NT\$ 3400

(實景詳見上圖)

- 毛巾及多功能架
- 附5000LC-2 掛架固定座
- TOWEL SHELF & MULTI-PURPOSE RACK
- 304 STAINLESS STEEL
- W460 X D260 X H160MM



**ST2298L** NT\$ 4000

- 毛巾及多功能架
- 附5000LC-2 掛架固定座
- TOWEL SHELF & MULTI-PURPOSE RACK
- 304 STAINLESS STEEL
- W620 X D260 X H160MM



**ST2295-2H** NT\$ 3600

- 方形雙層活動架 (釘式)
- 附 5000C-2 掛架固定座 薄底
- DOUBLE ACTIVE RACKS
- 304 STAINLESS STEEL
- W280 X D170 X H480MM
- 內徑高度 268MM



**ST2297B-2** NT\$ 3800

- 雙層活動架
- 附 4000C-2 掛架固定座
- DOUBLE ACTIVE RACKS
- 304 STAINLESS STEEL
- W285 X D270 X H455MM
- 內徑高度 257MM



**ST2297B-3** NT\$ 5100

- 三層活動架
- 附 4000C-2 掛架固定座
- TRIPLE ACTIVE RACKS
- 304 STAINLESS STEEL
- W285 X D270 X H775MM
- 內徑高度 上層 254MM
- 內徑高度 下層 306MM



**ST2299-2H** NT\$ 3000

- 半圓形雙層活動架 (釘式)
- 附 5000C-2 掛架固定座 薄底
- DOUBLE ACTIVE RACKS (1/2 ROUND)
- 304 STAINLESS STEEL
- W270 X D150 X H480MM
- 內徑高度 271MM



**ST2299B-2** NT\$ 3200

- 半圓形雙層活動架 (掛式 - 可活動)
- 附 4000C-2 掛架固定座
- DOUBLE ACTIVE RACKS (1/2 ROUND)
- 304 STAINLESS STEEL
- W270 X D150 X H460MM
- 內徑高度 255MM



**ST2299B-3** NT\$ 4500

- 半圓形三層活動架 (掛式 - 可活動)
- 附 4000C-2 掛架固定座
- TRIPLE ACTIVE RACKS (1/2 ROUND)
- 304 STAINLESS STEEL
- W270 X D150 X H775MM
- 內徑高度 上層 257MM
- 內徑高度 下層 302MM



**ST2299-2** NT\$ 3350

- 半圓形淋浴拉門活動架
- SHOWER DOOR DOUBLE RACKS (1/2 ROUND)
- 304 STAINLESS STEEL
- W270 X D275 X H950MM
- 淋浴拉門厚度 65MM
- 內徑高度 311MM



**ST2295-2** NT\$ 3900

- 方形淋浴拉門活動架
- SHOWER DOOR DOUBLE RACKS
- 304 STAINLESS STEEL
- W280 X D260 X H950MM
- 淋浴拉門厚度 65MM
- 內徑高度 308MM





**ST3266-01** NT\$ 1950

- 轉角架
- CORNER RACK
- 304 STAINLESS STEEL
- W230 X D235 X H57MM



**ST3266** NT\$ 2300

(實景詳見頁 38)

- 轉角架
- CORNER RACK
- 304 STAINLESS STEEL
- W230 X D235 X H95MM

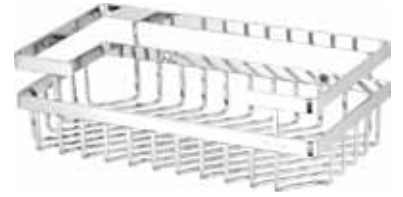

**ST3267** NT\$ 2650

- 單層置物架(扁型線條)
- 可另選購 7000C-2  
或 7200C-2 螺絲固定座
- SINGLE RACK
- 304 STAINLESS STEEL
- W320 X D170 X H100MM

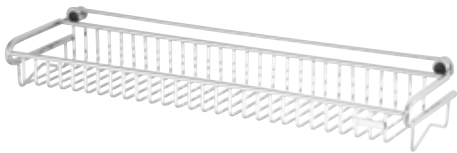

**ST3268XL** NT\$ 3050

- 平台置物架
- 附 5000SC-2 掛架固定座 厚底
- MIRROR RACK
- 304 STAINLESS STEEL
- W600 X D160 X D90MM

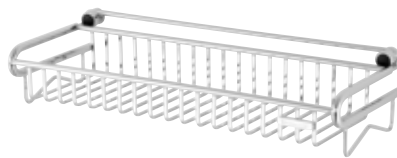

**ST3268-1** NT\$ 2500

(實景詳見頁 45)

- 單層置物架(扁型線條)
- 附5000SC-2掛架固定座 厚底
- SINGLE MULTI-PURPOSE RACK
- 304 STAINLESS STEEL
- W420 X D160 X D90MM



**ST3268-1S** NT\$ 1950

- 單層置物架-窄版(扁型線條)
- 附5000SC-2掛架固定座 厚底
- SINGLE MULTI-PURPOSE RACK
- 304 STAINLESS STEEL
- W275 X D160 X H90MM



**ST3268** NT\$ 4500

- 雙層置物架(扁型線條、強化玻璃6MM)
- 附5000SC-2掛架固定座 厚底
- DOUBLE MULTI-PURPOSE RACK
- 304 STAINLESS STEEL
- W470 X D260 X H340MM
- 內徑高度 250MM



**ST3268-2** NT\$ 4850

- 雙層置物架(扁型線條)
- 附5000SC-2掛架固定座 厚底
- DOUBLE MULTI-PURPOSE RACKS
- 304 STAINLESS STEEL
- W420 X D160 X D380MM
- 內徑高度 285MM

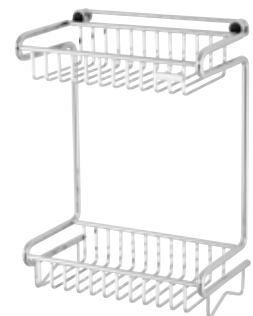

**ST3268-2S** NT\$ 3750

- 雙層置物架-窄版(扁型線條)
- 附5000SC-2掛架固定座 厚底
- DOUBLE MULTI-PURPOSE RACKS
- 304 STAINLESS STEEL
- W275 X D160 X H380MM
- 內徑高度 285MM





**ST2295SH** NT\$ 1500

- 小方形置物架
- 附5000SC-2掛架固定座 厚底
- SINGLE TRAY S
- 304 STAINLESS STEEL
- W225 X D145 X H95MM



**ST2299LH** NT\$ 1400

- 半圓置物架
- 附 5000SC-2掛架固定座 厚底
- SINGLE TRAY
- 304 STAINLESS STEEL
- W270 X D150 X H100MM



**ST2296SSH** NT\$ 1650

- W280 X D175 X H95MM

**ST2297SSH** NT\$ 1500

- W280 X D140 X H95MM

**ST2297LSH** NT\$ 1700

- W320 X D145 X H95MM

- 小方形置物架
- 附5000SC-2掛架固定座 厚底
- SINGLE TRAY S
- 304 STAINLESS STEEL



**ST2297LLH** NT\$ 2400

- 大方形置物架
- 附 3061-30 滴水盤 X1
- 附 5000SC-2 掛架固定座 厚底
- SINGLE TRAY L
- 304 STAINLESS STEEL
- W320 X D225 X H110MM



**ST2297SLH** NT\$ 1900

- 大方形置物架-不附滴水盤
- 附 5000SC-2掛架固定座 厚底
- SINGLE TRAY L
- 304 STAINLESS STEEL
- W280 X D235 X H95MM



**ST6632** NT\$ 1900 (實景詳見上圖)

- 多功能盥洗架
- 附壓克力牙刷杯X2 壓克力香皂盤X1
- 可另選購7000C-2或 7200C-2 螺絲固定座
- MULTI-FUNCTION TUMBLER HOLDER
- 304 STAINLESS STEEL
- W310 X D170 X H142MM



**ST6632A-2** NT\$ 1600

- 多功能盥洗架組
- 附活動式杯架X2
- 可另選購香皂盤(3506A)
- MULTI-FUNCTION BRUSH HOLDER
- 304 STAINLESS STEEL
- W298 X D150 X H120MM



**ST6632A** NT\$ 950

- 小型多功能盥洗架 S
- MULTI-FUNCTION BRUSH HOLDER S
- 304 STAINLESS STEEL
- W125 X D150 X H120MM



**2005GA** NT\$ 100

- 壓克力牙刷杯
- TOOTH-BRUSH CUP
- ACRYLIC



**2006GA** NT\$ 180

- 壓克力皂盤
- SOAP DISH
- ACRYLIC



**3506A** NT\$ 70

- 肥皂盒
- SOAP DISH
- 適用ST6632A-2、ST6632A、3506



**ST6632B** NT\$ 350

- 活動式杯架
- ACTIVE CUP RACK
- 304 STAINLESS STEEL
- W90 X D90 X H35MM





**ST3033S-2CH** NT\$ 3500

(實景詳見下圖)

- 雙層轉角架 (掛·放兩用)
- 附5000C-2掛架固定座 薄底
- CORNER RACK DOUBLE S
- 304 STAINLESS STEEL
- W230 X D235 X H420MM
- 內徑高度 320MM

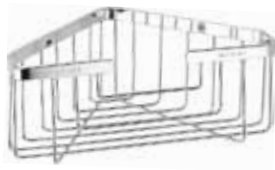

**ST3209** NT\$ 1250

- 單層轉角架
- CORNER RACK
- 304 STAINLESS STEEL
- W195 X D195 X H87MM



**ST3033S-3CH** NT\$ 5100

- 三層轉角架 S (掛·放兩用)
- 附5000C-2掛架固定座 薄底
- CORNER RACK TRIPLE S
- 304 STAINLESS STEEL
- W230 X D235 X H680MM
- 內徑高度上層 240MM
- 內徑高度下層 320MM



**ST3209-2** NT\$ 2550

- 雙層轉角架
- CORNER RACK DOUBLE
- 304 STAINLESS STEEL
- W195 X D195 X H348MM
- 內徑高度 270MM



**ST3033SH** NT\$ 2000

- W225 X D225 X H175MM

**ST3033H** NT\$ 2500

- W320 X D320 X H175MM

- 轉角架-釘式
- 附5000SC-2掛架固定座 厚底
- CORNER RACK
- 304 STAINLESS STEEL



**ST2296S-2H** NT\$ 3400  
(實景詳見右圖)

- 雙層架 (掛、放兩用)
- 附5000SC-2掛架固定座 厚底
- DOUBLE RACK S
- 304 STAINLESS STEEL
- W280 X D150 X H440MM
- 內徑高度 300MM



**ST2296S-3H** NT\$ 4950

- 三層架 (掛、放兩用)
- 附5000SC-2掛架固定座 厚底
- TRIPLE RACK S
- 304 STAINLESS STEEL
- W280 X D150 X H675MM
- 內徑高度上層 250MM
- 內徑高度下層 300MM



**ST2295S-2H** NT\$ 2700

- 小方型雙層置物架
- 附5000SC-2掛架固定座 厚底
- DOUBLE SMALL RACK
- 304 STAINLESS STEEL
- W225 X D152 X H350MM
- 內徑高度 230MM



**ST2297-2H** NT\$ 3900

- 大方型雙層置物架
- 附5000SC-2掛架固定座 厚底
- DOUBLE LARGE RACK
- 304 STAINLESS STEEL
- W320 X D233 X H425MM
- 內徑高度 280MM



**ST3208A-2** NT\$ 2700

- 雙層抽取式衛生紙架
- DOUBLE FACIAL TISSUE HOLDER
- 304 STAINLESS STEEL
- W280 X D120 X H365 MM
- 內徑高度 250MM



**ST3208** NT\$ 1250

- 抽取式衛生紙架
- FACIAL TISSUE BOX
- 304 STAINLESS STEEL
- W265 X D120 X H90MM

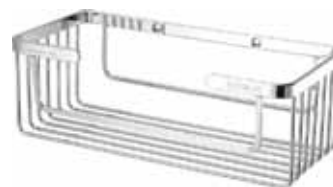

**ST3208A** NT\$ 1250

- 抽取式衛生紙架
- FACIAL TISSUE HOLDER
- 304 STAINLESS STEEL
- W256 X D120 X H90MM



**1008T-6**

NT\$ 920

- 抽取式衛生紙盒-桌上型-霧白色
- FACIAL TISSUE BOX(ACRYLIC )
- ACRYLIC 壓克力
- W230 X D130 X H100MM

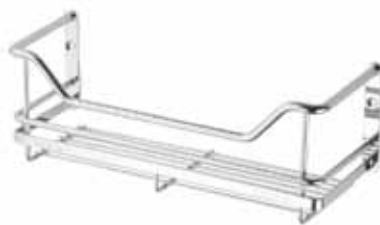

**ST5230A**

NT\$ 1350

- 衛生紙架(單瓶架)
- 可浴櫃內用
- FACIAL TISSUE HOLDER
- 304 STAINLESS STEEL
- W310 X D110 X H115MM



**1008B-8**

NT\$ 1300

- 平版式衛生紙盒-掛放兩用-白色
- TOILET BOX
- ACRYLIC 壓克力
- W250 X D200 X H120MM
- (厚度 5MM)



**1008T-8**

NT\$ 1200

- 抽取式衛生紙盒-掛放兩用-白色
- FACIAL TISSUE BOX(ACRYLIC )
- ACRYLIC 壓克力
- W250 X D150 X H115MM
- (厚度 5MM)



**ST1008**

NT\$ 1650

- 平版衛生紙架
- 附5000SC-2掛架固定座 厚底
- TOILET PAPER RACK
- 304 STAINLESS STEEL
- W235 X D217 X H95MM



**ST3205**

NT\$ 700

- 面紙架(釘式)
- FACIAL TISSUE HOLDER
- 304 STAINLESS STEEL
- W135 X D105 X H195MM



**ST3205T**

NT\$ 900

- 面紙架(釘式)可橫、直用
- FACIAL TISSUE HOLDER
- 304 STAINLESS STEEL
- W150 X D125 X H235MM



**1006W** NT\$ 3200

(實景詳見左圖)

- 壁掛式雙面伸縮鏡
- CHROME PLATING不鏽鋼色
- 伸縮桿為青銅材質
- 底座為 304不鏽鋼
- REVERSIBLE WALL-EXTENSION MIRROR
- 鏡面 Ø190MM
- 伸縮長度：一段175MM 二段330MM
- 平面·放大(放大兩倍)



**1006LC** NT\$ 2500

- 桌上型雙面明鏡
- 平面·放大(放大兩倍)
- 鏡面 Ø190MM
- PORTABLE 2-SIDE MIRROR
- CHROME PLATING 不鏽鋼色
- BRASS 青銅材質
- W270 X D130 X H350MM



**ST3001-5** NT\$ 500

- 五聯勾 附固定頭
- W340MM

**ST3001-8** NT\$ 650

- 八聯勾 附固定頭
- W492MM
- HOOK RAILS
- 304 STAINLESS STEEL



**ST3001-5S** NT\$ 350

- 五聯勾
- W335MM

**ST3001-8S** NT\$500

- 八聯勾
- W462MM
- 可另選購7000C-2或7200C-2固定頭
- HOOK RAILS
- 304 STAINLESS STEEL



**1006SC** NT\$ 2000

- 桌上型明鏡
- PORTABLE MIRROR
- CHROME PLATING 不鏽鋼色
- BRASS 青銅材質
- W165 X D110 X H300MM



**STC0103** NT\$ 760

- 三聯掛衣勾
- ROBE HOOK RAILS
- 304 STAINLESS STEEL
- W280 X D53 X H85MM



**3612** 不鏽鋼色 W 30CM NT\$ 1400

**3618** 不鏽鋼色 W 45CM NT\$ 1500

- 扶手
- BRASS 青銅材質
- GRAB BAR



**ST3207T** NT\$ 450

- 肥皂架 掛、放兩用
- SOAP HOLDER
- 304 STAINLESS STEEL
- W140 X D90 X H20MM



**ST3207** NT\$ 370

- (實景詳見頁 43)
- 肥皂架(桌上型)
  - SOAP HOLDER
  - 304 STAINLESS STEEL
  - W140 X D90 X H20MM



**ST3203D** NT\$ 950

- 海綿置物架
- 附 3061-20 滴水盤 X1、吸盤、螺絲
- 可另選購 2800C 固定掛架
- SPONGE HOLDER W/PLATE
- 304 STAINLESS STEEL
- W225 X D125 X H85MM



**2303-01** NT\$ 1150

- 捲筒衛生紙架(有蓋)
- 蓋子為 304 不鏽鋼鏡面拋光
- PAPER HOLDER WITH LID
- 304 STAINLESS STEEL LID
- CHROME PLATING 不鏽鋼色
- W168 X D70 X H110MM



**2003CC** NT\$ 1150

- 捲筒衛生紙架
- 蓋子為 304 不鏽鋼鏡面拋光
- PAPER HOLDER WITH LID
- 304 STAINLESS STEEL
- CHROME PLATING 不鏽鋼色
- W160 X D65 X H109MM



**2003C** NT\$ 800

- 捲筒衛生紙架(毛巾架)
- PAPER ROLL HOLDER (TOWEL HOLDER)
- CHROME PLATING 不鏽鋼色
- W160 X D65 X H100MM



**2001C** NT\$ 750 (實景詳見下圖)

- 毛巾環
- TOWEL RING
- CHROME PLATING 不鏽鋼色
- W160 X D65 X H180MM
- 圓內徑140MM



**2002BC** NT\$ 1500

- 馬桶刷架
- 青銅固定座
- 附馬桶刷 & 瓷杯
- TOILET BRUSH & PORCELAIN CUP WITH BRASS HOLDER
- W122 X D152 X H400MM
- 圓內徑 95MM



**2002BD** NT\$1150

- 馬桶刷架
- 青銅固定座
- 附馬桶刷 & 玻璃杯
- TOILET BRUSH & GLASS CUP WITH BRASS HOLDER
- W123 X D151 X H420MM
- 圓內徑 95MM



**2002GC** NT\$ 650

- 馬桶刷杯
- TOILET BRUSH CUP
- 瓷器 PROCELAIN
- 有排水孔



**2002G** NT\$ 280

- 馬桶刷杯
- TOILET BRUSH CUP
- 玻璃 GLASS
- 有排水孔



**2002CB** NT\$ 270

- 馬桶刷
- TOILET BRUSH
- CHROME PLATING 不鏽鋼色
- W390MM





### 1000 系列 (5 分管)

<b>1245C</b> 不鏽鋼色 45CM	NT\$700
<b>1260C</b> 不鏽鋼色 60CM	NT\$750
<b>1275C</b> 不鏽鋼色 75CM	NT\$800
<b>1290C</b> 不鏽鋼色 90CM	NT\$900

- 單桿毛巾掛桿組
- 青銅掛桿固定座 +304 不鏽鋼掛桿
- TOWEL BAR
- BRASS HOLDER
- 304 STAINLESS STEEL TUBE
- 掛桿固定座 Ø25 X D60MM (內距 40MM)



### 2000 系列 (5 分管)

<b>2245C</b> 不鏽鋼色 45CM	NT\$1140
<b>2260C</b> 不鏽鋼色 60CM	NT\$1190
<b>2275C</b> 不鏽鋼色 75CM	NT\$1240
<b>2290C</b> 不鏽鋼色 90CM	NT\$1340

- 單桿毛巾掛桿組
- 青銅掛桿固定座 +304 不鏽鋼掛桿
- TOWEL BAR
- BRASS HOLDER
- 304 STAINLESS STEEL TUBE
- 掛桿固定座 Ø55 X D65MM (內距 40MM)



### 3000 系列 (5 分管)

<b>3245C</b> 不鏽鋼色 45CM	NT\$760
<b>3260C</b> 不鏽鋼色 60CM	NT\$810
<b>3275C</b> 不鏽鋼色 75CM	NT\$860
<b>3290C</b> 不鏽鋼色 90CM	NT\$960

- 單桿毛巾掛桿組
- 鋅合金固定座 +304 不鏽鋼掛桿
- TOWEL BAR
- ZIN DIE CAST HOLDER
- 304 STAINLESS STEEL TUBE
- 掛桿固定座 W30 X D60 X D66MM (內距 40MM)

## 不鏽鋼鏡面拋光毛巾桿



### 2600 系列 (5 分管)

<b>2645C</b> 45CM	NT\$1100
<b>2660C</b> 60CM	NT\$1150
<b>2675C</b> 75CM	NT\$1200
<b>2690C</b> 90CM	NT\$1300

- 單桿毛巾掛桿組
- 303 不鏽鋼鏡面拋光掛桿固定座 +304 不鏽鋼掛桿
- TOWEL BAR
- 303 STAINLESS STEEL HOLDER
- 304 STAINLESS STEEL TUBE
- 掛桿固定座 Ø25 X D62MM(內距 40MM)



### STH2700 系列 (5 分管)

<b>STH2745</b> 45CM	NT\$1700
<b>STH2760</b> 60CM	NT\$1750
<b>STH2775</b> 75CM	NT\$1800
<b>STH2790</b> 90CM	NT\$1900

- 單桿毛巾掛桿組
- 304 不鏽鋼鏡面拋光固定座 +304 不鏽鋼掛桿
- TOWEL BAR
- 304 STAINLESS STEEL HOLDER
- 304 STAINLESS STEEL HOLDER TUBE
- 掛桿固定座 Ø22 X D62MM (內距 40MM)

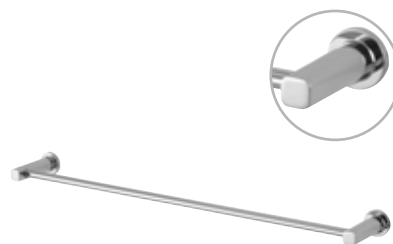

<b>STH6160</b> 60CM	NT\$2100
<b>STH6175</b> 75CM	NT\$2150
<b>STH6190</b> 90CM	NT\$2250

- 單桿毛巾掛桿組
- 304 不鏽鋼鏡面拋光固定座 +304 不鏽鋼掛桿
- TOWEL BAR
- HOLDER & TUBE
- 304 STAINLESS STEEL
- 掛桿固定座 Ø38 X D87MM (內距 62MM)



### STH6100 不鏽鋼系列 (4 分管)

<b>STH6160-2</b> 60CM	NT\$2650
<b>STH6175-2</b> 75CM	NT\$2750
<b>STH6190-2</b> 90CM	NT\$2950

- 雙桿毛巾掛桿組
- 304 不鏽鋼鏡面拋光固定座 +304 不鏽鋼掛桿
- TWIN TOWEL BAR
- 304 STAINLESS STEEL HOLDER & TUBE
- 掛桿固定座 Ø38 X D114MM (內距 46MM/ 內桿至外桿距離 36MM)



## 採用新一代無鉛無銅無毒製程



### M-H919

NT\$ 12000

(實景詳見 49 頁)

- LED 防霧鏡
- 橫掛
- 開關：右下揮手
- W800 X H600MM



NEW

### M-H716

NT\$ 11000

(實景詳見 48 頁右下)

- LED 防霧鏡
- 橫掛
- 開關：右下觸碰
- W800 X H600MM



### M-H720

NT\$ 9980

- LED 噴砂防霧鏡 + 時間
- 直掛
- 開關：右下揮手
- W500 X H700MM

## 易潔鏡專區

### 易潔鏡特色

採用特定奈米鍍模塗層，水氣不易凝結。

髒污、水漬不易附著於鏡子表面，鏡面用清水即可清潔。

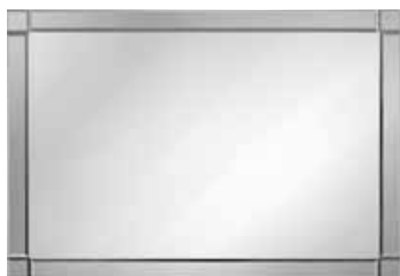

### M-1195

NT\$ 4350

(實景詳見頁 48 左上)

- 雙層易潔鏡 (可橫、直掛)
- MIRROR
- W680 X H480MM



### M-1528

NT\$ 3750

- 鑲雕易潔鏡 (可橫、直掛)
- MIRROR
- W700 X H500MM



### M-122

NT\$ 2950

- W600 X H450MM

### M-122L

NT\$ 3950

- W800 X H600MM
- 長方形易潔鏡 (可橫、直掛)
- MIRROR



NEW

### M-1023B

NT\$ 6500

- 長方形易潔鏡 (可橫、直掛)
- 黑色 鋁框
- W600 X H800MM



**M-526** NT\$ 3500

(實景詳見頁 49)

- 雙層防霧鏡 (可橫、直掛)
- MIRROR
- W480 X H680MM



**M-1006** NT\$ 2700

- 橢圓形防霧鏡
- MIRROR
- W480 X H680MM



**M-1005** NT\$ 2700

- 長方形防霧鏡 (可橫、直掛)
- MIRROR
- W680 X H480MM



**6008G** W560 X H600MM NT\$ 3000

**6008GL** W800 X H600MM NT\$ 3600

- 方形防霧鏡 (可橫、直掛)
- MIRROR

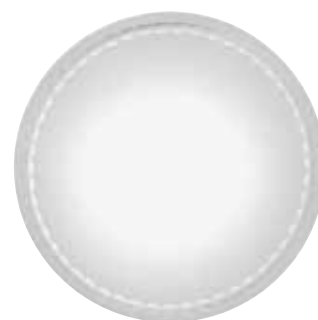

**8008G** NT\$ 3300

- 圓形防霧鏡
- MIRROR
- φ 585MM

符合台灣 CNS、日本 JIS R3202、歐盟 ROHS、北美 ASTM 檢驗標準。經 CASS Test (ASTM B368) 480hrs 實驗證實，更具耐腐蝕性與耐候性。使用台玻電子級專用玻璃製鏡。

#### 產品優點：

抗化學性耐腐蝕性能，為傳統一般鏡 4 倍以上。  
無鉛無銅無毒製程，符合環保訴求。  
為世界未來發展主流趨勢是綠色環保裝飾建材新選擇。

#### 鏡子清潔保養方式：

使用後請關掉電源。  
請先以濕布擦鏡子，然後用乾布將鏡面水份擦淨，可讓鏡面潔淨。  
請勿以強酸、強鹼清潔劑清洗鏡面。  
請勿用水沖洗鏡面及開關。





**3500-2** NT\$ 900/ 一對

- 固定座 / 一對 HOLDER
- CHROME PLATING 不鏽鋼色
- BRASS 青銅材質
- 可夾玻璃最大厚度 10MM
- W50 X D25 X H26MM



**3507** NT\$ 1650

- 鏡子平台架
- 附 3500-2 固定座 / 一對
- 10MM GLASS SHELF WITH 3500-2 HOLDER
- 10MM 霧面強化玻璃
- W600 X D145MM



**3508MCG** NT\$ 1500

- W400 X D146MM

**3508CG** NT\$ 1750

- W600 X D146MM

**3508CGL** NT\$ 2000

- W800 X D146MM
- 鏡子平台架
- 附 3500-2 固定座 / 一對
- 10MM GLASS SHELF WITH 3500-2 HOLDER
- 10MM OG 邊強化玻璃



**3509LFG** NT\$ 2200

- 鏡子平台架 附圍欄
- 附 3500-2 固定座 / 一對
- 10MM GLASS SHELF WITH 3500-2 HOLDER
- 10MM OG 邊強化玻璃
- W600XD146MM



**3517** NT\$ 2300 (實景詳見上圖)

- 霧面玻璃平台架 - 附圍欄
- 附 3500-2 固定座 / 一對
- 10MM GLASS SHELF WITH RAIL & 3500-2 HOLDER
- 10MM 霧面強化玻璃
- W600 X D150MM



**3523MK** NT\$ 1750

- 轉角架 - 附圍欄
- 附 3500-2 固定座一對
- 8MM GLASS CORNER HOLDER WITH 3500-2 HOLDER
- 8MM OG 邊強化玻璃
- W250 X D250MM



**3512MFG** NT\$ 1850

- 轉角架 - 附圍欄
- 附 3500-2 固定座 / 一對
- 8MM GLASS CORNER HOLDER WITH 3500-2 HOLDER
- 8MM OG 邊強化玻璃
- W250 X D250MM



**3511CG** NT\$ 1600

- 轉角架
- 附 3500-2 固定座 / 一對
- 10MM GLASS CORNER HOLDER WITH 3500-2 HOLDER
- 10MM OG 邊強化玻璃
- W280 X D280MM



**STH3700-2** NT\$ 1500/ 一對

- 固定座 / 一對 HOLDER
- 304 不鏽鋼鏡面拋光
- 304 STAINLESS STEEL
- 可夾玻璃最大厚度 10MM
- W50 X D35 X H21MM



**STH3707** NT\$ 2250

- 鏡子平台架
- 附 STH3700-2 固定座 / 一對
- 10MM GLASS SHELF WITH STH3700-2 HOLDER
- 10MM 霧面強化玻璃
- W600 X D145MM

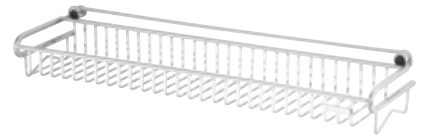

**ST3268XL** NT\$ 3050

- 平台置物架
- 附 5000SC-2 掛架固座 厚底
- MIRROR RACK
- 304 STAINLESS STEEL
- W600 X D160 X D90MM



**STH3709LFG** NT\$ 2800

- 鏡子平台架 附圍欄
- 附 STH3700-2 固定座 / 一對
- 10MM GLASS SHELF WITH STH3700-2 HOLDER
- 10MM OG 邊強化玻璃
- W600XD146MM



**STH3717** NT\$ 2900

- 霧面玻璃平台架 - 附圍欄
- 附 STH3700-2 固定座 / 一對
- 10MM GLASS SHELF WITH RAIL & STH3700-2 HOLDER
- 10MM 霧面強化玻璃
- W600 X D150MM



**STH3708MCG** NT\$ 2100

- W400 X D146MM

**STH3708CG** NT\$ 2350

- W600 X D146MM

**STH3708CGL** NT\$ 2600

- W800 X D146MM

- 鏡子平台架
- 附 STH3700-2 固定座 / 一對
- 10MM GLASS SHELF WITH STH3700-2 HOLDER
- 10MM OG 邊強化玻璃



**2217** NT\$ 650

- 平台圍欄組
- RAIL FOR GLASS SHELF
- 304 STAINLESS STEEL
- W551 X H36MM



**STH3723MK** NT\$ 2350

- 轉角架 - 附圍欄
- 附 STH3700-2 固定座一對
- 8MM GLASS CORNER HOLDER WITH STH3700-2 HOLDER
- 8MM OG 邊強化玻璃
- W250 X D250MM



**STH3712MFG** NT\$ 2450

- 轉角架 - 附圍欄
- 附 STH3700-2 固定座 / 一對
- 8MM GLASS CORNER HOLDER WITH STH3700-2 HOLDER
- 8MM OG 邊強化玻璃
- W250 X D250MM



**STH3711CG** NT\$ 2200

- 轉角架
- 附 STH3700-2 固定座 / 一對
- 10MM GLASS CORNER HOLDER WITH STH3700-2 HOLDER
- 10MM OG 邊強化玻璃
- W280 X D280MM

## 雙層旋轉直立架



**6650-01** NT\$ 5500

- CHROME PLATING 不鏽鋼色
- 桿子 H480MM
- 6691-1方型置物架(大)2個  
HOLDER L (RECTANGLE SHAPE)  
304 STAINLESS STEEL  
W280 X D140 X H60 MM



**6656C** NT\$ 5400

- CHROME PLATING 不鏽鋼色
- 桿子H480MM
- 6691-1 方型置物架(大)  
HOLDER L (RECTANGLE SHAPE)  
304 STAINLESS STEEL  
W280 X D140 X H60MM
- 6691-2 方型置物架(小)  
HOLDER S (RECTANGLE SHAPE)  
304 STAINLESS STEEL  
W225 X D140 X H60MM



**6650-02** NT\$ 5310

- CHROME PLATING 不鏽鋼色
- 桿子 H480MM
- 6691-1方型置物架(大)  
HOLDER L (RECTANGLE SHAPE)  
304 STAINLESS STEEL  
W280 X D140 X H60 MM
- 6691-3圓形置物架  
HOLDER S (ROUND SHAPE)  
304 STAINLESS STEEL  
Ø178 X H60MM



**6650-03** NT\$ 4850

- CHROME PLATING 不鏽鋼色
- 桿子 H480MM
- 6691-1 方型置物架 (大)  
HOLDER L (RECTANGLE SHAPE)  
304 STAINLESS STEEL  
W280 X D140 X H60MM
- 6670-2C 毛巾環架  
SMALL TOWEL RING  
Ø160MM 圓內徑 140MM

NEW



**6650-07** NT\$ 5010

- CHROME PLATING 不鏽鋼色
- 桿子 H480MM
- 6691-3 圓形置物架  
HOLDER S (ROUND SHAPE)  
304 STAINLESS STEEL  
Ø178 X H60MM
- 6670-1C 衛生紙架 (有蓋)  
TOILET PAPER HOLDER WITH LID  
W165 X D110MM

NEW



**6650-08** NT\$ 5200

- CHROME PLATING 不鏽鋼色
- 桿子 H480MM
- 6691-1 方型置物架 (大)  
HOLDER L (RECTANGLE SHAPE)  
304 STAINLESS STEEL  
W280 X D140 X H60MM
- 6670-1C 衛生紙架 (有蓋)  
TOILET PAPER HOLDER WITH LID  
W165 X D110MM

## 三層旋轉直立架



**6670-01** NT\$ 7160

- CHROME PLATING 不鏽鋼色
- 桿子 H695MM
- 6691-1方型置物架(大)  
HOLDER L (RECTANGLE SHAPE)  
304 STAINLESS STEEL  
W280 X D140 X H60 MM
- 6691-2方型置物架(小)  
HOLDER S (RECTANGLE SHAPE)  
304 STAINLESS STEEL  
W225 X D140 X H60 MM
- 6691-3圓形置物架  
HOLDER S (ROUND SHAPE)  
304 STAINLESS STEEL  
Ø178 X H60 MM



NEW

**6670-07** NT\$ 7050

- CHROME PLATING 不鏽鋼色
- 桿子 H695MM
- 6691-1 方型置物架 (大)  
HOLDER (RECTANGLE SHAPE)  
304 STAINLESS STEEL  
W280 X D140 X H60MM
- 6691-2 方型置物架 (小)  
HOLDER S (RECTANGLE SHAPE)  
304 STAINLESS STEEL  
W225 X D140 X H60MM
- 6670-1C 衛生紙架 (有蓋)  
TOILET PAPER HOLDER WITH LID  
W165 X D110MM



**6670-03** NT\$ 7260

- CHROME PLATING 不鏽鋼色
- 桿子 H695MM
- 6691-1方型置物架(大)2個  
HOLDER L (RECTANGLE SHAPE)  
304 STAINLESS STEEL  
W280 X D140 X H60 MM
- 6691-3圓形置物架  
HOLDER S (ROUND SHAPE)  
304 STAINLESS STEEL  
Ø178 X H60 MM



NEW

**6670-08** NT\$ 6800

- CHROME PLATING 不鏽鋼色
- 桿子 H695MM
- 6691-1 方型置物架 (大) 2 個  
HOLDER (RECTANGLE SHAPE)  
304 STAINLESS STEEL  
W280 X D140 X H60MM
- 6670-2C 毛巾環架  
TWOEL RING  
Ø160MM 圓內徑 140MM



**6670-05** NT\$ 7450

- CHROME PLATING 不鏽鋼色
- 桿子 H695MM
- 6691-1 方型置物架 (大) 3 個  
HOLDER (RECTANGLE SHAPE)  
304 STAINLESS STEEL  
W280 X D140 X H60MM



NEW

**6670-09** NT\$ 6610

- CHROME PLATING 不鏽鋼色
- 桿子 H695MM
- 6691-1 方型置物架 (大)  
HOLDER (RECTANGLE SHAPE)  
304 STAINLESS STEEL  
W280 X D140 X H60MM
- 6691-3 圓形置物架  
HOLDER S (ROUND SHAPE)  
304 STAINLESS STEEL  
Ø178 X H60MM
- 6670-2C 毛巾環架  
TWOEL RING  
Ø160MM 圓內徑 140MM





**1000C-2** 掛桿頭 NT\$ 500 / 一對  
**1000CM** (中通) NT\$ 250 / 一個

- 掛桿固定座
- HOLDER
- CHROME PLATING 不鏽鋼色
- BRASS 青銅材質
- $\phi$  25 X D60MM



**2000C-2** 掛桿頭 NT\$ 940 / 一對  
**2000CM** (中通) NT\$ 470 / 一個

- 掛桿固定座
- HOLDER
- CHROME PLATING 不鏽鋼色
- BRASS 青銅材質
- $\phi$  55 X D65MM



**3000C-2** 掛桿頭 NT\$ 560 / 一對  
**3000M** (中通) NT\$ 280 / 一個

- 掛桿固定座
- HOLDER
- CHROME PLATING 不鏽鋼色
- ZINC DIE CAST 鋅合金
- W30 X D60 X H66MM

## 上櫃用掛桿頭



**2500-2** NT\$ 900 / 一對  
**2500** (中通) NT\$ 450 / 一個  
 (實景詳見頁 69)

- 掛桿上櫃固定座 (霧面)
- HOLDER
- ALUMINUM 鋁
- W25 X D62 X H70MM

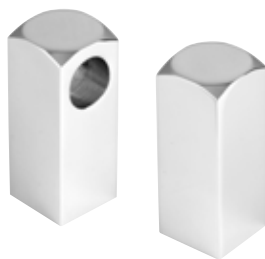

**STH2700-2** 掛桿頭 NT\$ 1500 / 一對  
**STH2700M** (中通) NT\$ 750 / 一個  
 (實景詳見頁 70)

- 掛桿固定座
- HOLDER
- 304 STAINLESS STEEL 不鏽鋼
- 304 不鏽鋼鏡面拋光
- W23 X D62 X H23MM



**2600-2** 掛桿頭 NT\$ 900 / 一對  
**2600M** (中通) NT\$ 450 / 一個  
 (實景詳見頁 56)

- 掛桿固定座
- HOLDER
- 303 STAINLESS STEEL 不鏽鋼
- 303 不鏽鋼鏡面拋光
- $\phi$  25 X D62MM



**2500-A** NT\$ 25

- 5 分管 矽膠塞頭



**4000C-2** NT\$ 240 / 一對

- 掛架固定座
- HOLDER
- CHROME PLATING 不鏽鋼色
- BRASS 青銅材質
- $\phi$  19 X D57MM



**5000C-2** (薄底) NT\$ 150 / 一對

- $\phi$  20 X D21MM

**5000SC-2** (厚底) NT\$ 150 / 一對

- $\phi$  20 X D25MM

**5000LC-2** (薄底) NT\$ 270 / 一對

- $\phi$  29 X D27MM

- 掛架固定座
- HOLDER
- CHROME PLATING 不鏽鋼色
- BRASS 青銅材質



**7000C-2** NT\$ 120 / 一對

- 螺絲固定頭 螺帽青銅材質
- 螺帽CHROME PLATING 不鏽鋼色
- $\phi$  13 X D12MM
- 適用品項  
ST3001-5S, ST3001-8S  
ST3267, ST6632



**ST3001-5** NT\$ 500

- 五聯勾 附固定頭
- W340MM

**ST3001-8** NT\$ 650

- 八聯勾 附固定頭
- W492MM
- HOOK RAILS
- 304 STAINLESS STEEL



**ST3001-5S** NT\$ 350

- 五聯勾
- W335MM

**ST3001-8S** NT\$ 500

- 八聯勾
- W462MM
- 可另選購 7000C-2 或 7200C-2 螺絲固定頭
- HOOK RAILS
- 304 STAINLESS STEEL



**STC0103** NT\$ 760

- 三聯掛衣勾
- ROBE HOOK RAILS
- 304 STAINLESS STEEL
- W280 X D53 X H85MM



**7200C-2** NT\$ 190/一對

- 螺絲固定頭 螺帽青銅材質
- 螺帽 CHROME PLATING 不鏽鋼色
- 適用品項

ST3001-5S ST3001-8S  
ST3205 ST3205T ST3208  
ST3208A ST3208A-2 ST3209  
ST3209-2 ST3267  
ST5230A ST6632  
ST3266 ST3266-01



**ST3001-3** NT\$ 150/三入  
(實景詳見頁 63)

- 單S掛勾
- S-HOOK SINGLE
- 304 STAINLESS STEEL



**ST3002** NT\$ 90

(實景詳見頁 58)

- 雙S掛勾
- S-HOOK DOUBLE
- 304 STAINLESS STEEL



<b>ST2045</b>	45CM	NT\$ 200
<b>ST2060</b>	60CM	NT\$ 250
<b>ST2075</b>	75CM	NT\$ 300
<b>ST2090</b>	90CM	NT\$ 400
<b>ST2120</b>	120CM	NT\$ 500
<b>ST2150</b>	150CM	NT\$ 700
<b>ST2180</b>	180CM	NT\$ 950

- 亮麗不鏽鋼管
- THICKNESS 厚度 0.8~1.2MM
- 304 STAINLESS STEEL
- φ 16MM (5分管)



**ST3036** NT\$ 250

- 砧板掛勾
- CARVING BOARD HOOK
- 304 STAINLESS STEEL
- W72 X D112 X H75MM



### ST3015H

NT\$ 2400

- 刀柄砧板架 掛式
- 附 3061-25 滴水盤 X1
- KNIFE & CARVING BOARD HOLDER
- 304 STAINLESS STEEL
- W250 X D170 X H458MM
- 砧板厚度 45MM



### ST3215T NT\$ 1800 (實景詳見頁 60)

- 桌上型刀柄砧板架
- 附 3061-25L 滴水盤 X1
- KNIFE CARVING BOARD STAND
- 304 STAINLESS STEEL
- W290 X D165 X H255MM
- 砧板厚度 35 / 20MM



### ST3215-1 NT\$ 1700

- 桌上型刀柄砧板架 (單層砧板架)
- 附 3061-25L 滴水盤 X1
- KNIFE CARVING BOARD STAND
- 304 STAINLESS STEEL
- W290 X D165 X H255MM
- 砧板厚度 50MM



### ST3015C

NT\$ 1550

- 刀柄架 掛式
- KNIFE HOLEDR
- 304 STAINLESS STEEL
- W250 X D90 X H415MM



### ST3015ST-01 NT\$ 1150

- 刀柄架 門板釘式
- 可加購 5000C-2 掛架固定座
- KNIFE HOLDER
- 304 STAINLESS STEEL
- W245 X D60 X H265MM



### ST3215L NT\$ 2100

- 桌上型 刀柄 砧板 鍋蓋架
- 附 3061-30 滴水盤 X 1
- KNIFE & CARVING BOARD & LID STAND
- 304 STAINLESS STEEL
- W300 X D230 X H 255MM
- 鍋蓋深度 83 MM
- 砧板厚度 43 MM

NEW



### ST3015F

NT\$ 2700

- 刀柄 砧板 鍋蓋架 掛式
- 附 3061-25 滴水盤 X 1
- KNIFE & CARVING BOARD & LID HOLDER
- 304 STAINLESS STEEL
- W257 X D187 X H443MM
- 鍋蓋深度 78 MM
- 砧板厚度 43 MM

NEW



**ST3215TS** NT\$ 2000 (實景詳見頁 55)

- 桌上型刀柄砧板架
- 附 3061-20 滴水盤 X1
- KNIFE CARVING BOARD STAND
- 304 STAINLESS STEEL
- W185 X D150 X H235MM
- 砧板厚度 30MM



**ST3015T** NT\$ 1350

- 桌上型刀柄鍋蓋架
- 附 3061-20 滴水盤 X1
- KNIFE & LID STAND
- 304 STAINLESS STEEL
- W203 X D142 X H235MM



**ST3026T** NT\$ 650

- 桌上型砧板架
- CARVING BOARD STAND
- 304 STAINLESS STEEL
- W155 X D123 X H120MM
- 砧板厚度 30 / 30MM



**ST3023F** NT\$ 2750

(實景詳見頁 63)

- 雙層調味罐架 掛式
- 可放保鮮膜、調味罐
- SPICE RACK
- 304 STAINLESS STEEL
- W300 X D192 X H360MM
- 內徑高度 140MM



**ST3030L** NT\$ 2000

- 調味罐架
- 可放保鮮膜、調味罐
- SPICE RACK
- 304 STAINLESS STEEL
- W350 X D180 X H275MM
- 內徑高度 125MM



**ST3026C** NT\$ 2350

- 砧板架 掛式
- CARVING BOARD RACK
- 304 STAINLESS STEEL
- W405 X D145 X H350MM
- 砧板厚度 23 / 30 / 30MM



**ST3023H** NT\$ 3100

- 桌上型雙層調味架
- 附 3061-25L 滴水盤 X1
- 附 5000SC-2 掛架固定座 厚底
- DOUBLE SPICE RACKS
- 304 STAINLESS STEEL
- W300 X D178 X H307MM
- 內徑高度 170MM







**ST3088AH** NT\$ 1650

- 單層活動架
- 附 5000SC-2 掛架固定座 厚底
- SINGLE ACTIVE RACK
- 304 STAINLESS STEEL
- W335 X D145 X H93MM

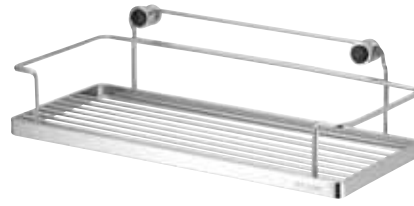

**ST3088BH** NT\$ 1600

- 單層調味架
- 附5000SC-2掛架固定座 厚底
- SINGLE SPICE RACK
- 304 STAINLESS STEEL
- W335 X D145 X H93MM



**ST3088** NT\$ 4150

- 三層紙巾及調味架活動式
- PAPER TOWEL TRIPLE RACKS FOR REFRIGERATOR
- 304 STAINLESS STEEL
- W335 X D160 X H465MM
- 內徑高度 上層 118MM
- 內徑高度 下層 98MM



**ST3088A** NT\$ 1950

- 單層活動架
- SINGLE ACTIVE RACK
- 304 STAINLESS STEEL
- W335 X D155 X H285MM



**ST3088B** NT\$ 1900

- 單層調味架
- SINGLE SPICE RACK
- 304 STAINLESS STEEL
- W335 X D155 X H285MM



**ST3088F** NT\$ 4150

- 冰箱三層紙巾及調味架
- PAPER TOWEL TRIPLE RACKS FOR REFRIGERATOR
- 304 STAINLESS STEEL
- W335 X D155 X H445MM
- 內徑高度 上層 164MM
- 內徑高度 下層 95MM



**ST2297L** NT\$ 4350

- 雙層活動掛架
- 附 3061-30 滴水盤 X1
- DOUBLE ACTIVE RACK W / PLATE
- 304 STAINLESS STEEL
- W320 X D250 X H455MM
- 內徑高度 232MM







**ST3020** NT\$ 2350

- 多用途掛架 長勾
- MULTI-PURPOSE RACK
- 304 STAINLESS STEEL
- W455 X D185 X H330MM

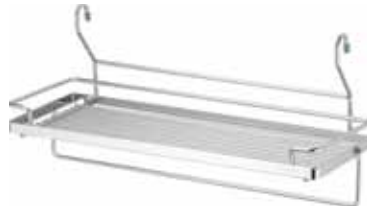

**ST3020S** NT\$ 2150

- 多用途掛架 短勾
- MULTI-PURPOSE RACK
- 304 STAINLESS STEEL
- W455 X D185 X H210MM



**ST3028C** NT\$ 3000 (實景詳見頁 58)

- 調味罐及瓶罐架
- SPICE WITH BOTTLE RACK
- 304 STAINLESS STEEL
- W400 X D200 X H360MM



**ST3029-01** NT\$ 1800

(實景詳見頁 57)

- 桌上型雙層調理罐架
- DOUBLE SPICE RACKS
- 304 STAINLESS STEEL
- W305 X D105 X H280MM
- 內徑高度 156MM

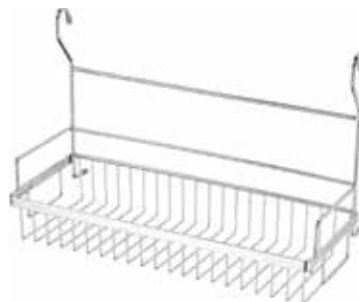

**ST3029** NT\$ 2300

- 瓶罐架
- BOTTLE RACK
- 304 STAINLESS STEEL
- W450 X D210 X H300MM



**ST3028** NT\$ 2750

- 調味罐及瓶罐架
- SPICE WITH BOTTLE RACK
- 304 STAINLESS STEEL
- W345 X D230 X H355MM





**ST3023** NT\$ 2600

- 調味罐及紙巾架
- SPICE WITH PAPER TOWEL HOLDER
- 304 STAINLESS STEEL
- W300 X D195 X H355MM



**ST3023C** NT\$ 2300

(實景詳見頁 70)

- 調味罐及紙巾架
- SPICE WITH PAPER TOWEL HOLDER
- 304 STAINLESS STEEL
- W330 X D140 X H300MM



**ST3088C** NT\$ 1350

- 單層紙巾架 活動式
- SINGLE ACTIVE TOWEL RACK
- 304 STAINLESS STEEL
- W280 X D165 X H290MM



**ST3088CH** NT\$ 1050

- 單層紙巾架(活動式)
- 附5000SC-2掛架固定座 厚底
- SINGLE ACTIVE TOWEL RACK
- 304 STAINLESS STEEL
- W280 X D135X H110MM

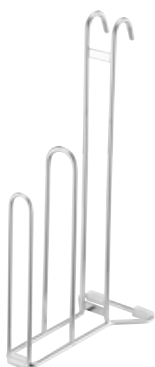

**ST2003D** NT\$ 850

- 紙巾架
- 掛式及桌上型兩用
- PAPER TOWEL HOLDER
- 304 STAINLESS STEEL
- W95 X D176 X H310MM

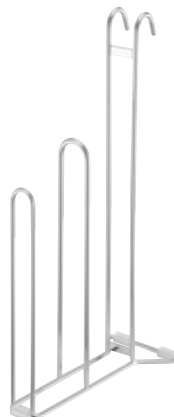

**ST2003DL** NT\$ 950

- 紙巾架-大型紙巾適用
- 掛式及桌上型兩用
- PAPER TOWEL HOLDER
- 304 STAINLESS STEEL
- W95 X D213 X H380MM



**ST2003HA** NT\$ 1100

- 桌上型紙巾架
- PAPER TOWEL STAND
- 304 STAINLESS STEEL
- 直徑  $\phi$  162 X H300MM



**ST3027B** NT\$ 1000

- 鍋蓋架 掛式 附集水盒
- LID HOLDER WITH A BOX
- 304 STAINLESS STEEL
- W205 X D140 X H455MM



**ST3027C** NT\$ 1050

- 鍋蓋架 釘式 附集水盒
- 附5000C-2掛架固定座 薄底
- LID HOLDER WITH A BOX
- 304 STAINLESS STEEL
- W205 X D140 X H415MM



**ST3027F** NT\$ 1250

- 鍋蓋砧板架-掛式 附集水盒
- LID & CARVING BOARD HOLDER
- 304 STAINLESS STEEL
- W205 X D160 X H470MM



**3027P** NT\$ 70

- 集水盒
- 適用 ST3027C、ST3027B、ST3027F



**ST3027-01** NT\$ 1350

- 桌上型鍋蓋砧板架
- 附 3061-25 滴水盤 X1
- LID & CARVING BOARD HOLDER
- 304 STAINLESS STEEL
- W255 X D170 X H190MM
- 砧板厚度 30 / 25MM
- 鍋蓋深度 58MM



**ST3031** NT\$ 1500

- 桌上型平底鍋架 附滴水盤
- 附 3061-30 滴水盤 X 1
- SAUCEPAN STAND
- 304 STAINLESS STEEL
- W318 X D230 X H194MM



**ST3027T** NT\$ 1800

- 桌上型鍋蓋架
- 附 3061-25 滴水盤 X1
- LID STAND
- 304 STAINLESS STEEL
- W255 X D170 X H420MM





**ST3078D-01** NT\$ 8200

- 雙層置物架
- 附 3061-50 滴水盤 X2
- 附 5000SC-2 掛架固定座 厚底  
ST3003-01 餐具桶、插盤架、單 S 掛勾 X3
- DOUBLE MULTI-PURPOSE RACK
- 304 STAINLESS STEEL
- W575 X D245 X H460MM
- 內徑高度 303MM

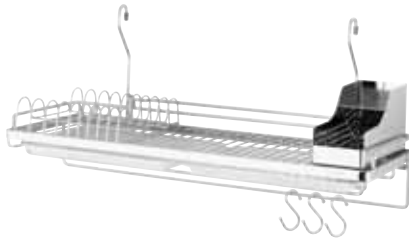

**ST3068S-01** NT\$ 6100

- 碗盤架
- 附 3061-30 滴水盤 X2
- ST3003-01 餐具桶、插盤架、單 S 掛勾 X 3
- BOWL AND DISHES RACK WITHOUT TUBE & HOLDER
- 304 STAINLESS STEEL
- W640 X D250 X H290MM

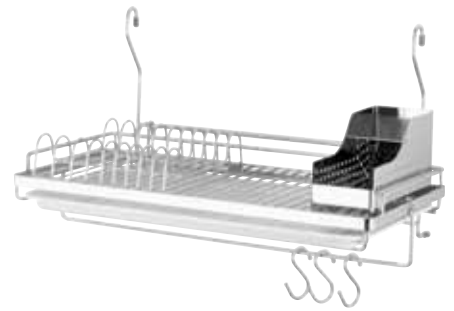

**ST3078S-01** NT\$ 5550

- 碗盤架 - 掛式
- 附 3061-50 滴水盤 X1
- ST3003-01 餐具桶、插盤架、單 S 掛勾 X 3
- BOWL AND DISHES RACK WITHOUT TUBE & HOLDER
- 304 STAINLESS STEEL
- W502 X D280 X H290MM



**ST3078D** NT\$ 7000

- 雙層置物架
- 附 3061-50 滴水盤 X2
- 附 5000SC-2 掛架固定座 厚底  
插盤架、餐具盒、單 S 掛勾 X3、
- DOUBLE MULTI-PURPOSE RACK
- 304 STAINLESS STEEL
- W575 X D245 X H460MM
- 內徑高度 303MM



**ST3068S** NT\$ 4900

(實景詳見頁 60)

- 碗盤架
- 附 3061-30 滴水盤 X2
- 附插盤架、餐具盒、單 S 掛勾 X3
- BOWL AND DISHES RACK WITHOUT TUBE & HOLDER
- 304 STAINLESS STEEL
- W640 X D250 X H290MM



**ST3078S** NT\$ 4350

- 碗盤架 - 掛式
- 附 3061-50 滴水盤 X1
- 附插盤架、餐具盒、單 S 掛勾 X3
- BOWL AND DISHES RACK WITHOUT TUBE & HOLDER
- 304 STAINLESS STEEL
- W502 X D280 X H290MM

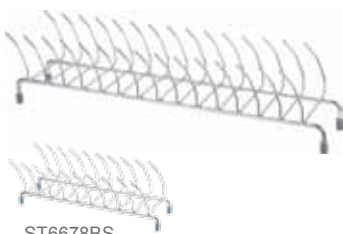

ST6678BS

**ST6678B** NT\$ 750

- 14 格
- W400 X D90 X H100MM

**ST6678BS** NT\$ 600

- 9 格
- W270 X D90 X H90MM
- 碗盤架
- DISHES HOLDER
- 304 STAINLESS STEEL



ST6678CS

**ST6678C** NT\$ 950

- 12 格
- W400 X D90 X H105MM

**ST6678CS** NT\$ 700

- 8 格
- W265 X D90 X H98MM
- 盤子架
- DISHES HOLDER
- 304 STAINLESS STEEL



**ST3078F** NT\$ 5900

- 雙層置物架 (掛、放兩用)
- 附 3061-50 大滴水盤 X2
- 附 5000SC-2 掛架固定座 厚底
- DOUBLE MULTI-PURPOSE RACK
- 304 STAINLESS STEEL
- W575 X D245 X H460MM
- 內徑高度 303MM





**ST2298D-01** NT\$ 5850

- 碗盤架
- 附 3061-30 滴水盤 X2
- 附 5000LC-2 掛架固定座
- ST3003-01 餐具桶、插盤架
- BOWL AND DISHES RACK WITH 5000LC-2 HOLDER
- 304 STAINLESS STEEL
- W620 X D260 X H90MM

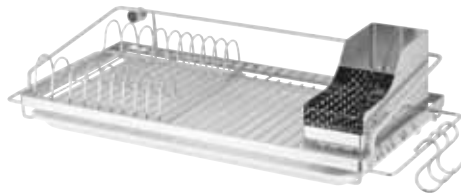

**ST3078A-01** NT\$ 4950

- 碗盤架 - 釘式
- 附 3061-50 滴水盤 X1
- 附 5000SC-2 掛架固定座 厚底
- ST3003-01 餐具桶、插盤架、單 S 掛勾 X 3
- SINGLE MULTI-PURPOSE RACK WITH 5000SC-2 HOLDER
- 304 STAINLESS STEEL
- W575 X D245 X H100MM

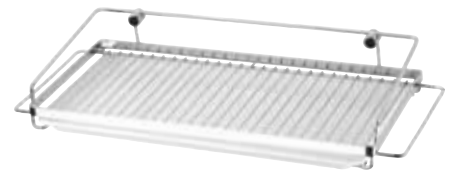

**ST3078** NT\$ 2650

- 單層置物架
- 附 3061-50 滴水盤 X1
- 附 5000SC-2 掛架固定座 厚底
- SINGLE MULTI-PURPOSE RACK WITH 5000SC-2 HOLDER
- 304 STAINLESS STEEL
- W575 X D245 X H100MM



**ST2298D** NT\$ 4650

- 碗盤架
- 附 3061-30 滴水盤 X2
- 附 5000LC-2 掛架固定座
- 插盤架、餐具盒
- BOWL AND DISHES RACK WITH 5000LC-2 HOLDER
- 304 STAINLESS STEEL
- W620 X D260 X H90MM



**ST3078A** NT\$ 3750

- 碗盤架 - 釘式
- 附 3061-50 滴水盤 X1
- 附 5000SC-2 掛架固定座 厚底
- 插盤架、餐具盒、單 S 掛勾 x3
- SINGLE MULTI-PURPOSE RACK WITH 5000SC-2 HOLDER
- 304 STAINLESS STEEL
- W575 X D245 X H100MM



**ST2297A** NT\$ 2650

- 小型碗盤架
- 附 3061-30 滴水盤 X1
- SMALL BOWL AND DISHES RACK
- 304 STAINLESS STEEL
- W320 X D255 X H285MM



**ST6678DP-01** NT\$ 5500

- 雙層置物架 (扁條)
- 附 5000C-2 掛架固定座 薄底
- 附 ST6678A 瓶罐架
- DOUBLE MULTI-PURPOSE RACK
- 304 STAINLESS STEEL
- W468 X D280 X H440MM







**ST3060-01** NT\$ 950

- 碗架
- BOWL HOLDER
- 304 STAINLESS STEEL
- Ø 150 X H195MM



**ST3060D** NT\$ 1600

- 桌上型碗盤架
- 附 3061-30 滴水盤 X1
- DISHES HOLDER W/PLATE
- 304 STAINLESS STEEL
- W323 X D210 X H105MM



**ST3060L** NT\$ 1150

- 桌上型盤子架
- 附 3061-30 滴水盤 X1
- DISHES HOLDER
- 304 STAINLESS STEEL
- W312 X D226 X H110MM



**ST3060** NT\$ 800

- 盤子架 可拉籃內用
- DISHES HOLDER
- 304 STAINLESS STEEL
- W205 X D205 X H60MM



**ST3008D-2** NT\$ 3250

(實景詳見上圖)

- 桌上型雙層碗盤架
- 附 3061-30 滴水盤 X2
- DOUBLE MULTI-PURPOSE RACK
- 304 STAINLESS STEEL
- W350 X D230 X H315MM
- 內徑高度 220MM



**ST3008D** NT\$ 2150

- 桌上型置物盤
- 附 3061-30 滴水盤 X1
- DISHES HOLDER W/PLATE
- 304 STAINLESS STEEL
- W350 X D245 X H110MM



**ST3008** NT\$ 2050

- 桌上型水果盤
- 附 3061-30 滴水盤 X1
- FRUIT HOLDER
- 304 STAINLESS STEEL
- W355 X D250 X H150MM



**ST3052** NT\$ 3900

- 全展 W316 X D506MM
- 收納 Ø53 X D506MM
- 適用四方型水槽



- 滴水捲簾
- ROLLABLE DISHES HOLDER
- 304 STAINLESS STEEL
- 食用級耐熱矽膠
- 20 支 304 不鏽鋼扁條



**ST3013T** NT\$ 1050

- 水槽碗盤籃
- DISHES DRAINER
- 304 STAINLESS STEEL
- W510 X D188 X H110MM
- 內徑 W325 X D175 X H95MM

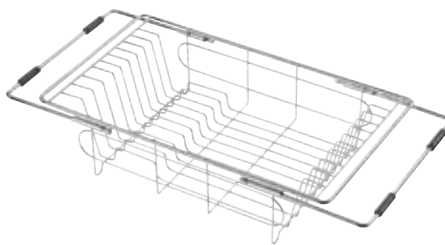

**ST3013TL** NT\$ 2050

- 可調式水槽碗盤籃
- ADJUSTABLE SINK BASKET
- 304 STAINLESS STEEL
- W430 X D255 X H110MM (全展 545MM)
- 內徑 W325 X D238 X H90MM



**ST3013TD** NT\$ 2300

(實景詳見下圖)

- 可調式水槽碗盤籃
- 附 3061-30 滴水盤 X1
- ADJUSTABLE SINK BASKET WITH PLATE
- 304 STAINLESS STEEL
- W430 X D255 X H130MM (全展 545MM)
- 內徑 W325 X D238 X H90MM



**ST3033DH** NT\$ 3600

- 雙層轉角架
- 適合廚房用
- 附5000SC-2掛架固定座 厚底
- CORNER RACK DOUBLE
- 304 STAINLESS STEEL
- W320 X D320 X H340MM
- 內徑高度 190MM

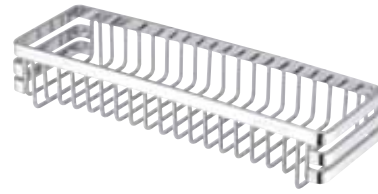

**ST3003-02** NT\$ 1000

- 平放筷架
- CUTLERY HOLDER
- 304 STAINLESS STEEL
- W265 X D62 X H49MM



**ST3003TS** NT\$ 850

(實景詳見頁 64)

- 餐具桶
- CUTLERY HOLDER
- 304 STAINLESS STEEL
- W82 X D100 X H120MM



**ST3003T** NT\$ 1400

- 餐具桶 - 長方型
- CUTLERY HOLDER
- 304 STAINLESS STEEL
- W178 X D103 X H151MM



**ST3003TL** NT\$ 1500

(實景詳見左上圖)

- 餐具桶 - 長方型
- 附滴水盤
- CUTLERY HOLDER
- 304 STAINLESS STEEL
- W212 X D107 X H152MM



**ST3003-01** NT\$ 1380

- 餐具桶
- CUTLERY HOLDER
- 304 STAINLESS STEEL
- W195 X D81 X H118MM



**ST3003TT** NT\$ 1700

- 餐具桶 - 長方型 掛式
- CUTLERY HOLDER
- 304 STAINLESS STEEL
- W178 X D126 X H290MM



**ST3003TF** NT\$ 1800

- 餐具桶 - 長方型 掛式
- 附滴水盤
- CUTLERY HOLDER
- 304 STAINLESS STEEL
- W212 X D132 X H290MM



**ST3003** NT\$ 900

- 餐具桶 掛、放兩用
- CUTLERY HOLDER
- 304 STAINLESS STEEL
- W116 X D116 X H275MM





**ST3016ST** NT\$ 1450

- 杯子架 六個入
- 附 3061-25 滴水盤 X1
- CUP STAND
- 304 STAINLESS STEEL
- W265 X D165 X H230MM



**ST3016LT** NT\$ 1700

- (實景詳見上圖)
- 杯子架 八個入
  - 附 3061-25L 滴水盤 X1
  - CUP STAND L
  - 304 STAINLESS STEEL
  - W305 X D165 X H235MM



**ST3018LT** NT\$ 1550

- 咖啡杯架 六個入
- 附 3061-25L 滴水盤 X1
- COFFEE CUP STAND
- 304 STAINLESS STEEL
- W310 X D170 X H237MM



**ST3016** NT\$ 950

- 杯子架 六個入
- 附 3061-25 滴水盤 X1
- CUP STAND
- 304 STAINLESS STEEL
- W245 X D160 X H215MM



**ST3016L** NT\$ 1050

- 杯子架 八個入
- 附 3061-25L 滴水盤 X1
- CUP STAND L
- 304 STAINLESS STEEL
- W300 X D165 X H225MM



**1008T-6** NT\$ 920

- 抽取式衛生紙盒-桌上型-霧白色
- FACIAL TISSUE BOX(ACRYLIC)
- ACRYLIC 壓克力
- W230 X D130 X H100MM

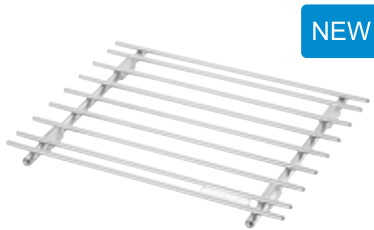

NEW

**ST3006K** NT\$ 800

- 隔熱墊
- HOT MAT
- 304 STAINLESS STEEL
- W238 X D200 X H15MM



**ST3006F** NT\$ 700

- 花型隔熱墊
- FLOWER SHAPE HOT MAT
- 304 STAINLESS STEEL
- $\phi$  240MM



**ST3006L** NT\$ 450

- $\phi$  205MM

**ST3006S** NT\$ 350

- $\phi$  180MM
- 隔熱墊
- HOT MAT
- 304 STAINLESS STEEL



**ST3051** NT\$ 1300

(實景詳見下圖)

- 馬克杯架
- MUG TREE
- 304 STAINLESS STEEL
- W180 X D180 X H330MM



**ST3005** NT\$ 600

(實景詳見頁 70)

- 餐具架 桌上型
- 附 3061-10 滴水盤 X1
- SPOON HOLDER
- 304 STAINLESS STEEL
- W110 X D116 X H270MM



**ST3005-01** NT\$ 450

- 湯勺架
- 附 3061-10 滴水盤 X1
- SPOON HOLDER
- 304 STAINLESS STEEL
- $\phi$  120 X H48MM



**3010TC** NT\$ 1850

- 可調式高腳杯架 桌上型
- ADJUSTABLE HANGING GLASS STAND
- 304 STAINLESS STEEL & 青銅材質
- W320 X D285 X H205MM(全展 355MM)
- 高腳杯入口徑 120MM





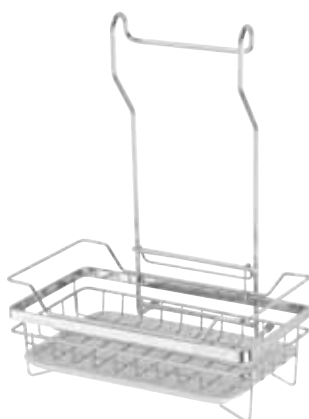

**ST3203F** NT\$ 1300

- 海棉置物架 - 掛式
- 附 3061-20 滴水盤 X1
- SPONGE HOLDER W/PATE
- 304 STAINLESS STEEL
- W225 X D172 X H285MM



**ST3201** NT\$ 400

- 海綿架 (附吸盤、螺絲)
- SPONGE HOLDER
- 304 STAINLESS STEEL
- W155 X D73 X H87MM



**ST3202** NT\$ 800

- 海綿瓶罐籃 (附吸盤 螺絲)
- SPONGE AND BOTTLE HOLDER
- 304 STAINLESS STEEL
- W180 X D130 X H100MM



**ST3203D** NT\$ 950

- 海綿置物架
- 附 3061-20 滴水盤 X1
- 附滴水盤 吸盤 螺絲
- SPONGE HOLDER W/PLATE
- 304 STAINLESS STEEL
- W225 X D125 X H85MM



**3200P** NT\$ 10/ 一個

- 吸盤
- 適用 ST3201、ST3202、ST3203D



**ST3202Z** NT\$ 950

- 海綿瓶罐籃
- 附 2800C 固定掛架
- 304 STAINLESS STEEL
- W180 X D130 X H100MM



**ST3203Z** NT\$ 1100

- 海綿置物架
- 附 2800C 固定掛架
- 304 STAINLESS STEEL
- W225 X D125 X H85MM



**2800C** 不鏽鋼色 NT\$ 250

- 固定掛架(不鏽鋼色 ST3201~ST3203D專用)
- HOLDER (USED BY ST3201~ST3203D)
- BRASS 青銅材質



**ST3207T** NT\$ 450

- 肥皂架 掛、放兩用
- SOAP HOLDER
- 304 STAINLESS STEEL
- W140 X D90 X H20MM



**ST3207** NT\$ 370

- 肥皂架 (桌上型)
- SOAP HOLDER
- 304 STAINLESS STEEL
- W140 X D90 X H20MM



**ST3010SC** NT\$ 600

- W327 X D150 X H40MM

**ST3010LC** NT\$ 650

- W387 X D150 X H40MM

- 高腳杯架
- 入口徑 120MM
- GOBLET RACK
- 304 STAINLESS STEEL



**ST3010SC-2** NT\$ 1100

- W327 X D285 X H40MM

**ST3010LC-2** NT\$ 1250

- W387 X D285 X H40MM

- 雙排高腳杯架
- 入口徑 120MM
- GOBLET RACK DOUBLE
- 304 STAINLESS STEEL



**ST3012SC** NT\$ 750

- 吊杯架 (小)
- HANGING CUP RACK S
- 304 STAINLESS STEEL
- W300 X D86 X H50MM



**ST3012LC** NT\$ 850

- 吊杯架 (大)
- HANGING CUP RACK L
- 304 STAINLESS STEEL
- W360 X D86 X H50MM



**1003** NT\$ 180

(實景詳見下圖)

- 餐具盒 (斜放、直放兩用)
- CUTLERY & TABLE WARE HOLDER
- ABS塑膠
- W200 X D85 X H138MM



**1001L** 乳白色 NT\$ 140

- 雙隔調味盒
- SEASONING CASE
- ABS塑膠
- W90 X D150 X H115MM



**1001S** 乳白色 NT\$ 120

- 單隔調味盒
- SEASONING CASE
- ABS塑膠
- W70 X D150 X H115MM



**3061-20** NT\$ 80

- W203 X D140MM

**3061-25** NT\$ 130

- W256 X D155MM

**3061-25L** NT\$ 150

- W300 X D155MM

**3061-30** NT\$ 170

- W300 X D215MM

**3061-50** NT\$ 350

- W475 X D240MM

- 滴水盤
- MELAMINE DISH
- 美耐皿

**3061-10** NT\$ 55

- 圓滴水盤
- SMALL ROUND PLATE
- 美耐皿
- $\phi$  110MM



Rinnai





NEW

**V1030L** NT\$ 5600

- 電子感應自動環保桶 – 橫向
- 430 不鏽鋼桶身 不鏽鋼色
- 附分隔式 可分類內桶
- 橫向向上
- 容量：30L (13+17L)
- W416 X D288 X H458MM
- 附 1 號電池 X 2



NEW

**V1016L** NT\$ 3200

- 電子感應自動環保桶 – 方型
- ABS 白色
- AUTO SENSITIVE DUSTBIN
- 方型上掀
- 容量：16L
- W240 X D241 X H383MM
- 附 3 號電池 X 2



**V1012LG** NT\$ 3500

- 電子感應自動環保桶 - 橫向
- 430 不鏽鋼烤漆桶身 黑色
- AUTO SENSITIVE DUSTBIN
- 橫向上掀
- 容量：12L
- W261 X D198 X H355MM
- 附 3 號電池 X 2



**V1012LF** NT\$ 3500

- 電子感應自動環保桶 - 橫向
- 430 不鏽鋼桶身 不鏽鋼色
- AUTO SENSITIVE DUSTBIN
- 橫向上掀
- 容量：12L
- W261 X D198 X H355MM
- 附 3 號電池 X 2



NEW

**V1008LB** NT\$ 3100

- 電子感應自動環保桶
- 白色
- ABS 上蓋、鍍鋅板桶身
- AUTO SENSITIVE DUSTBIN
- 容量：8L
- Ø236 X H344MM
- 附 3 號電池 X 2
- 內附塑膠桶 Ø 225 X H266MM



**V1010L** NT\$ 2800

- 電子感應自動環保桶 - 方型
- ABS 白色
- AUTO SENSITIVE DUSTBIN
- 方型上掀
- 容量：10L
- W261 X D261 X H335MM
- 附 3 號電池 X 2



**V1008LA** NT\$ 2400

- 電子感應自動環保桶 – 半圓
- ABS 白色
- AUTO SENSITIVE DUSTBIN
- 半圓上掀
- 容量：8L
- W244 X D191 X H280MM
- 附 3 號電池 X 2



**V1007L** NT\$ 2400

- 電子感應自動環保桶 - 直向
- ABS 白色
- AUTO SENSITIVE DUSTBIN
- 縱向上掀
- 容量：7L
- W150 X D230 X H310MM
- 附 3 號電池 X 2





**V1012LH** NT\$ 3500

- 電子腳觸自動環保桶 – 半圓
- 430 不鏽鋼桶身
- AUTO SENSITIVE DUSTBIN
- 半圓上掀
- 容量：12L
- W264 X D237 X H370MM
- 附 3 號電池 X 2



**SA-15CT51** NT\$ 2600

- 縱向長方形垃圾桶
- 430 不鏽鋼桶身 (厚度 0.4MM)
- 緩降腳踏式
- DUSTBIN
- 容量：15L
- W230 X D405 X H445MM
- 塑膠內桶  
W200 X D295 X H340MM



**SA-12CH66** NT\$ 2400

- 四方形垃圾桶
- 430 不鏽鋼桶身 (厚度 0.4MM)
- 緩降腳踏式
- DUSTBIN
- 容量 12L
- W252 X D320 X H450MM
- 塑膠內桶
- W240 X D235 X H350MM



**SA-05EF51-01** NT\$ 1700

- 直向長形垃圾桶
- 430 不鏽鋼桶身 (厚度 0.4MM)
- 緩降腳踏式
- DUSTBIN
- 容量：5L
- W163 X D280 X H287MM
- 塑膠內桶  
W163 X D216 X H236MM



**SA-05EF51-02** NT\$ 1500

- 四方錐形垃圾桶
- 430 不鏽鋼桶身 (厚度 0.4MM)
- 緩降腳踏式
- DUSTBIN
- 容量：5L
- W210 X D250 X H320MM
- 塑膠內桶  
W195 X D195 X H247MM



NEW

**SA-0503** NT\$ 1400

- 直向長形垃圾桶
- 桶身：烤漆，蓋子：430 不鏽鋼 (厚度 0.4MM)
- 緩降腳踏式
- DUSTBIN
- 容量：5L
- W205 X D260 X H300MM
- 塑膠內桶 Ø200 x H240MM



採用 430 不鏽鋼，更堅固耐用，抗腐蝕性更強不易生鏽。經 SGS 測試踩踏、按壓式設計開合可達 50000 次以上。

**清潔方式：**

請使用清水或中性清潔劑與乾布搭配擦拭表面，接著再使用柔軟乾布輕擦並待其自然乾燥，勿用鋼刷刷洗。

**注意事項：**

- 請使用中性清潔劑與乾布搭配擦拭表面
- 勿接近高溫和火源
- 勿擠壓或碰撞重摔，以免商品變形
- 避免潮濕





## 經典絕版

—— 出清商品，依現有庫存售完為止，恕不再另行公告通知 ——



**EA-176-C** 鍍鉻 NT\$ 13800

- ULYSSE 廚房無鉛伸縮龍頭
- 省水起泡頭濾網
- 二段式陶瓷閥芯
- ECO 節能手把
- 高品質下抽拉伸縮軟管握把
- 握把經隔熱處理避免燙傷



**EA-071-BR** 青古銅色 NT\$ 14700

- SHERLOCK 檯面無鉛龍頭
- 省水起泡頭濾網
- 輕鬆清洗起泡頭濾網
- 二段式陶瓷閥芯
- ECO 節能手把



**EA-101-N** 鍍鉻 NT\$ 15300

- ZENAWA 浴室無鉛龍頭
- 彷彿從竹子中流出水來



**ST2168** NT\$ 900

- 毛巾架
- TOWEL SHELF
- 304 STAINLESS STEEL
- W660 X D98 X H60MM



**ST2368** NT\$ 1700

- 置衣架
- CLOTHES SHELF
- 304 STAINLESS STEEL
- W660 X D250 X H60MM



**2312-2** 不鏽鋼色 120CM NT\$ 3050



**2360-2** 不鏽鋼色 60CM NT\$ 1900

**2375-2** 不鏽鋼色 75CM NT\$ 2000

**2390-2** 不鏽鋼色 90CM NT\$ 2200

- 雙桿毛巾掛桿組 4 分管
- 青銅掛桿固定座+#304不鏽鋼掛桿
- TWIN TOWEL BAR
- #304 STAINLESS STEEL TUBE
- 掛桿固定座  $\phi$  38 X D116MM (內距45MM/內桿至外桿距離32MM)(4分管)



**ST2169S** NT\$ 650

- W480 X D97 X H30MM

**ST2169L** NT\$ 750

- W630 X D97 X H30MM

- 毛巾架
- TOWEL SHELF
- 304 STAINLESS STEEL



**ST2369S** NT\$ 1650

- W480 X D250 X H30MM(S)

**ST2369L** NT\$ 1700

- W630 X D250 X H30MM(L)

- 置衣架
- CLOTHES SHELF
- 304 STAINLESS STEEL



9000 系列 (1" 圓管)

**9260C** 60CM NT\$ 1500

**9275C** 75CM NT\$ 1600

**9290C** 90CM NT\$ 1700

- 單桿毛巾掛桿組
- 青銅掛桿固定座 + #304 不鏽鋼掛桿
- TOWEL BAR (HOLDER+TUBE)
- #304 STAINLESS STEEL TUBE
- 1" 圓管
- 掛桿頭  $\phi$  65X90MM (內距62MM)



**ED-VS8650F** NT\$ 1200

- 304 不鏽鋼
- 沖洗器
- 附 304 不鏽鋼固定座
- 附 304 不鏽鋼 150CM 加密軟管
- 附銅製進水三通



**M-193** NT\$ 3150

- 雙層鑽雕防霧鏡
- MIRROR
- W700 X H500MM



**M-1004** NT\$ 5500

- 圓形水滴琉璃鏡 (無防霧)
- MIRROR
- Ø660MM



**2008G** NT\$ 2450

- 橢圓形防霧鏡
- MIRROR
- W520 X H700MM



**3300C-2** NT\$ 600/ 一對

- 固定座 / 一對 HOLDER
- CHROME PLATING 不鏽鋼色
- BRASS 青銅材質
- 可夾玻璃最大厚度 10MM
- W50 X D25 X H23MM



**3307SCG** NT\$ 800

- 鏡子平台架
- 附3300C 固定座一個
- 10MM GLASS SHELF WITH 3300C HOLDER
- 10MM OG 邊強化玻璃
- W300XD146MM



**3307LFG** NT\$ 1900

- 鏡子平台架 附圍欄
- 附 3300C-2 固定座 / 一對
- 10MM GLASS SHELF WITH 3300C-2 HOLDER
- 10MM OG 邊強化玻璃
- W600 X D146MM



**2007CG** NT\$ 1600

- 10MM強化玻璃鏡子平台架
- 10MM GLASS SHELF
- CHROME PLATING 不鏽鋼色
- W600XD155MM



**2017** NT\$ 2250

- 透明玻璃平台架-附圍欄
- 10MM強化玻璃鏡子平台架
- 10MM GLASS SHELF WITH RAIL
- W600 X D160MM



**3307MCG** NT\$ 1100

- W400 X D146MM

**3307CG** NT\$ 1350

- W600 X D146MM

**3307CGL** NT\$ 1550

- W800 X D146MM

- 鏡子平台架
- 附 3300C-2 固定座 / 一對
- 10MM GLASS SHELF WITH 3300C-2 HOLDER
- 10MM OG 邊強化玻璃



**3311CG** NT\$ 1200

- 轉角架
- 附 3500C-2 固定座 / 一對
- 10MM GLASS CORNER HOLDER WITH 3300C-2 HOLDER
- 10MM OG 邊強化玻璃
- W280 X D280MM



**3312SCG** NT\$ 1350

- W200 X D200MM

**3312MCG** NT\$ 1450

- W250 X D250MM

**3312CG** NT\$ 1500

- W310 X D310MM
- 轉角架 附圍欄
- 附 3300C-2 固定座 / 一對
- 8MM GLASS CORNER HOLDER WITH 3300C-2 HOLDER
- 8MM OG 邊強化玻璃



**2303** NT\$ 850

- 捲筒衛生紙架
- PAPER ROLL HOLDER
- W175 X D80MM



**3501** NT\$ 670

- 毛巾環
- TOWEL HOLDER
- ACRYLIC HOLDER
- W200 X D80MM



**3505** NT\$ 660

- 盥洗杯組
- TOOTHBRUSH HOLDER
- ABS 塑膠、ACRYLIC
- W120 X D105 X D119MM



**3506** NT\$ 650

- 香皂盤組
- SOAP DISH & ACRYLIC HOLDER
- ABS 塑膠、ACRYLIC
- W140 X D115MM



**3505A** NT\$ 70

- 盥洗杯
- TOOTHBRUSH CUP
- ABS 塑膠
- W109 X D77 X H119MM



**2006BC** NT\$ 630

- 附玻璃香皂盤
- GLASS SOAP



**2005BC** NT\$ 620

- 附玻璃杯 GLASS CUP



**2005C-1** NT\$ 750

- 玻璃牙刷牙膏單杯架
- SINGLE TOOTHPASTE-BRUSH & TUMBLER & GLASS CUP W/ACRYLIC HOLDER
- CHROME PLATING 不鏽鋼色
- 壓克力座 ACRYLIC HOLDER
- W160 X D112MM



**2005GC** NT\$ 115

- 玻璃牙刷杯
- TOOTH-BRUSH CUP
- GLASS

**2006BF** NT\$ 630

- 附壓克力香皂盤
- ACRYLIC CUP
- 香皂盤架
- SOAP DISH WITH BRASS HOLDER
- CHROME PLATING 不鏽鋼色
- W140 X D130 X H60MM

**2005BF** NT\$ 600

- 附壓克力杯 ACRYLIC CUP
- 牙刷杯架
- TUMBLER CUP WITH BRASS HOLDER
- CHROME PLATING 不鏽鋼色
- W70 X D115 X H110MM
- 圓內徑 60MM



**9006C** 不鏽鋼色 NT\$ 950

- 玻璃香皂盤架
- SOAP DISH HOLDER(SINGLE)
- W140 X D145MM



**9005C** 不鏽鋼色 NT\$ 950

- 玻璃牙刷杯架
- TOOTHPASTE BRUSH & TUMBLER HOLDER(SINGLE)
- W75 X D125MM



**9009C** 不鏽鋼色 NT\$ 950

- 單掛衣勾
- SINGLE ROBE HOOK
- W95 X D95MM



**2006GC** NT\$ 150

- 玻璃皂盤
- SOAP DISH
- GLASS



**8003C** NT\$ 450

- 捲筒衛生紙架 (毛巾架)
- PAPER ROLL HOLDER (TOWEL HOLDER)
- CHROME PLATING 不鏽鋼色
- W165 X D75 X H133MM



**8001C** NT\$ 450

- 毛巾環
- TOWEL RING
- CHROME PLATING 不鏽鋼色
- W158 X D178 X H203MM
- 圓內徑 135MM



**3100C** 不鏽鋼色 NT\$ 600

- 浴巾環
- BIGGER TOWEL RING
- CHROME PLATING 不鏽鋼色
- W170 X D60 X H195MM
- 圓內徑 145MM



**1010C** NT\$ 550

- 浴巾環
- BIGGER TOWEL RING
- CHROME PLATING 不鏽鋼色
- W170 X D60 X H175MM
- 圓內徑 145MM



**2003CL** NT\$ 850

- 壁式紙巾架
- PAPER TOWEL HOLDER
- CHROME PLATING 不鏽鋼色
- BRASS 青銅材質
- W250 X D70 X H105MM
- 內徑 230MM



**3012LC** 不鏽鋼色 NT\$ 750

- 吊杯架 (大)
- HANGING CUP RACK L
- CHROME PLATING
- BRASS 青銅材質
- W360 X D60MM



**ST2291** NT\$ 1000

- 書報架
- 附5000SC-2掛架固定座 厚底
- MAGAZINE RACK
- ACRYLIC
- 304 STAINLESS STEEL
- W320 X D100 X H230MM



**ST3037** NT\$ 350

- 鍋蓋架
- 304 STAINLESS STEEL
- W95 X D87 X H280MM



**ST3038** NT\$ 650

- 砧板掛架
- 304 STAINLESS STEEL
- W410 X D110 X H350MM

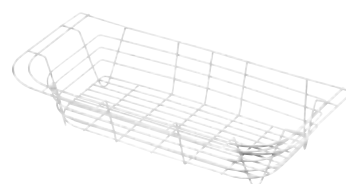

**ST3013L** NT\$ 700

- 水槽半邊籃
- DISHES DRAINER
- 304 STAINLESS STEEL
- W485 X D235 X H105MM
- 內徑 W380 X D190 X H90MM



**ST3025C** NT\$ 1400

- 紙巾架
- 可放紙巾、保鮮膜、鋁箔紙
- PAPER TOWEL HOLDER
- 304 STAINLESS STEEL
- W330 X D170 X H390MM



**ST3033S** NT\$ 2000

- W225 X D225 X H280MM

**ST3033** NT\$ 2500

- W320 X D320 X H280MM
- 轉角架-掛式
- CORNER RACK
- 304 STAINLESS STEEL



**ST3033D** NT\$ 3600

- 雙層轉角架
- 適合廚房用
- CORNER RACK DOUBLE
- 304 STAINLESS STEEL
- W320 X D320 X H450MM
- 內徑高度 190MM



**SAD2012AM** NT\$ 1700

- 圓形垃圾桶
- 430 不鏽鋼桶身 (厚度 0.4MM)
- 緩降腳踏式
- DUSTBIN
- 容量 : 12L
- Ø W250 X H430 · D340MM
- 塑膠內桶 Ø W250 X H305MM



**ST5823H** (釘式) NT\$ 1500

- 附 5000C-2 掛架固定座
- 髒衣籃
- LAUNDRY BASKET
- 304 STAINLESS STEEL
- W288 X D238 X H420MM





**ST6678DL** NT\$ 5250

- 雙層置物架
- 附 5000C-2 掛架固定座 薄底碗盤架、餐具桶
- DOUBLE MULTI-PURPOSE RACK
- 304 STAINLESS STEEL
- W468 X D280 X H440MM
- 內徑高度 336MM



**ST6678DR** NT\$ 3050

- 雙層置物架 (圓條)
- 附 5000C-2 掛架固定座 薄底
- DOUBLE MULTI-PURPOSE RACK
- 304 STAINLESS STEEL
- W468 X D280 X H440MM
- 內徑高度 336MM



**9850-01** NT\$ 900

- 烘碗機網架 (80cm)
- 附小碗架 X1+ 筷子盒
- 304 STAINLESS STEEL
- W745 X D280 X H270MM
- 烘碗機內用小碗架
- 304 STAINLESS STEEL
- W285 X D130 X H75MM

**9850-02** NT\$ 650

- 烘碗機網架 (80CM)
- 附 1003 ABS 筷子盒
- W745 X D280 X H270MM



**ST3076** NT\$ 5250

- 水槽上方置物組
- 附插盤架、餐具桶
- 可另選購滴水盤3061-30 x 2
- SINK MULTI-PURPOSE RACK
- 304 STAINLESS STEEL
- W712 X D250 X H440MM (內徑W685 X H355MM)



**ST3076S** NT\$ 3450

- 水槽上方置物架
- 可另選購滴水盤3061-30 x 2
- SINK MULTI-PURPOSE RACK
- 304 STAINLESS STEEL
- W712 X D250 X H440MM (內徑W685 X H355MM)

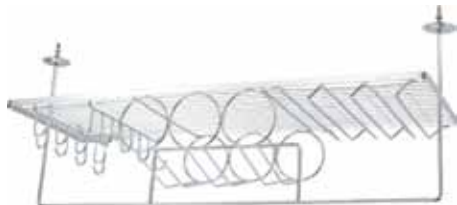

**ST3090** NT\$ 4300

- 吧台架
- BAR RACK
- 304 STAINLESS STEEL
- W950 X D300 X H380MM
- 高腳杯 入口徑 80MM

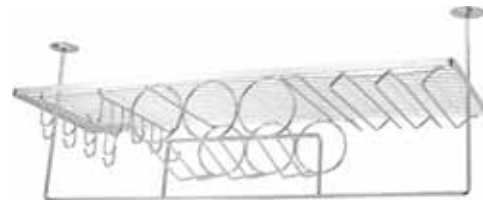

**ST3090A** NT\$ 4300

- 吧台架
- BAR RACK
- 304 STAINLESS STEEL
- W950 X D300 X H335MM
- 高腳杯 入口徑 80MM

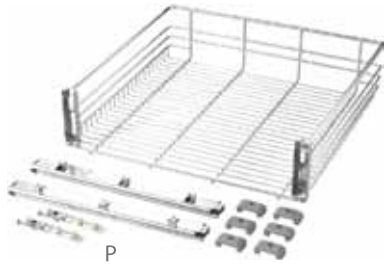

**抽屜式三邊拉籃**

- DRAWER TYPE
- P (鍍鉻) 三段式鋼珠滑軌



**D5300-2**

- 前托架及卡夾頭
- FRONT BRACKET WITH DOWEL



**抽屜式拉籃**

- DRAWER TYPE

**抽屜式三邊拉籃  
SLIDING BASKET (DRAWER TYPE)**

CABINET WIDTH 櫥櫃尺寸(外徑)	ITEM NO.	DIM. WXD X H(MM) 拉籃尺寸
	#304 STAINLESS STEEL+CHROME 不鏽鋼 + 鍍鉻	
400MM	ST5340P NT\$ 3200	320X483X140
450MM	ST5345P NT\$ 3300	370X483X140
500MM	ST5350P NT\$ 3500	420X483X140
720MM	ST5372P NT\$ 3900	640X483X140
900MM	ST5390P NT\$ 4150	820X483X140



**ST5218**

NT\$ 950

- 活動衣褲架
- 304 STAINLESS STEEL
- W450 X D110 X H40MM



### 開放式四邊拉籃

- OPEN DOOR TYPE
- PZ (鍍鉻) 三段式鋼珠滑軌



## 開放式四邊拉籃 SLIDING BASKET (OPEN DOOR TYPE)

CABINET WIDTH 櫥櫃尺寸(外徑)	ITEM NO.	DIM. WDXH(MM) 拉籃尺寸
	#304 STAINLESS STEEL+CHROME (不鏽鋼 + 鍍鉻)	
400MM	ST5440PZ NT\$ 3100	275X475X120
450MM	ST5445PZ NT\$ 3200	325X475X120
720MM	ST5472PZ NT\$ 3500	595X475X135
1000MM	ST5400PZ NT\$ 4200	875X475X135



### 5200C 不鏽鋼色 NT\$ 120 / 一對

- 吊衣座 (一對)
- DRESS-HANGER HOLDERS/PAIR
- BRASS 青銅料



### 吊衣桿 亮麗不鏽鋼管 DRESS-HANGER BAR 304 STAINLESS STEEL

- |   |   |
|---|---|
| <b>ST5040R</b> NT\$ 250<br>W355XD15XH30MM | <b>ST5080R</b> NT\$ 360<br>W755XD15XH30MM |
| <b>ST5045R</b> NT\$ 270<br>W405XD15XH30MM | <b>ST5090R</b> NT\$ 390<br>W855XD15XH30MM |
| <b>ST5050R</b> NT\$ 300<br>W455XD15XH30MM | <b>ST5100R</b> NT\$ 420<br>W955XD15XH30MM |
| <b>ST5060R</b> NT\$ 330<br>W555XD15XH30MM | <b>ST5100T</b> NT\$ 450<br>W991XD15XH30MM |